MPS 2016

On formal power series realized by two-way automata

Sylvain Lombardy

Bordeaux INP - LaBRI



One-way world

M.-P. Schützenberger : On the definition of a family of automata

Information and Control, 4(2-3), Sept. 1961, 245-270.



One-way weighted automaton

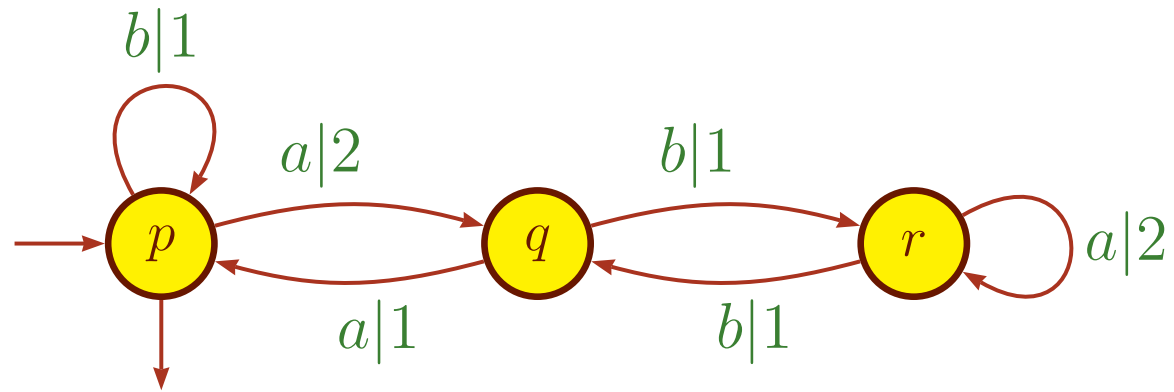

One-way weighted automaton

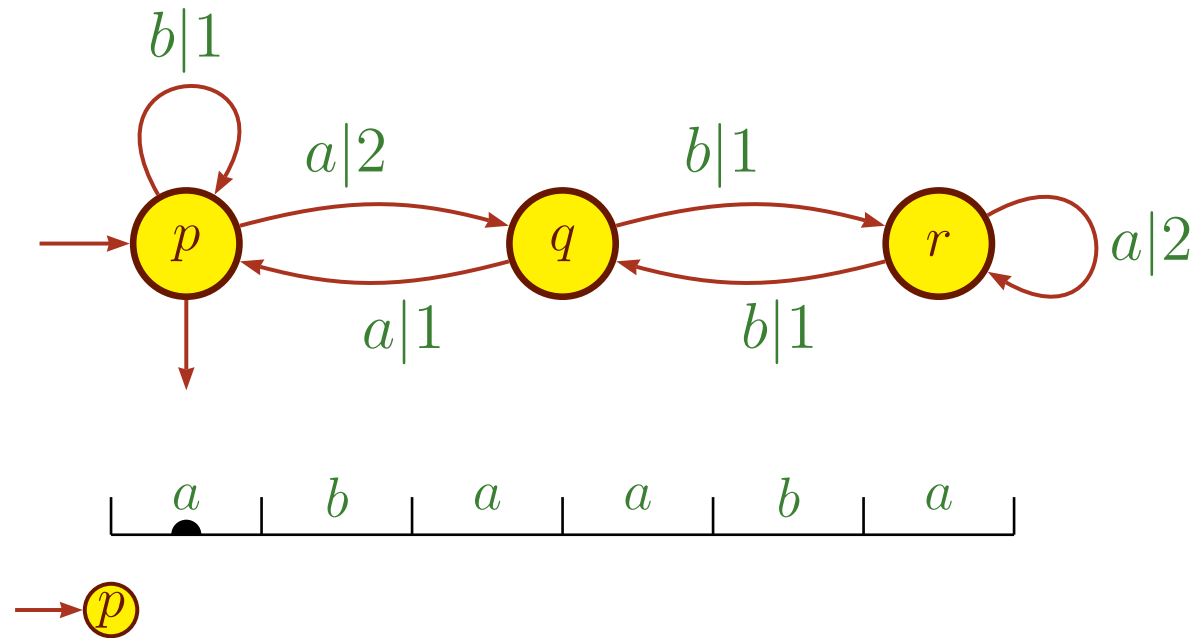

One-way weighted automaton

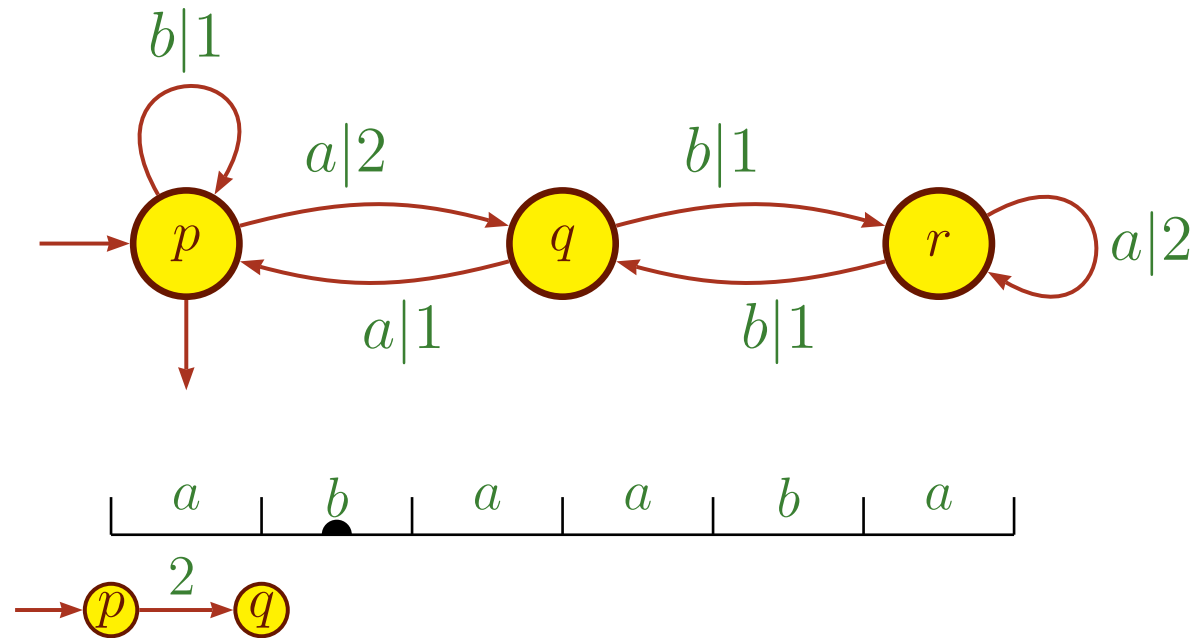

One-way weighted automaton

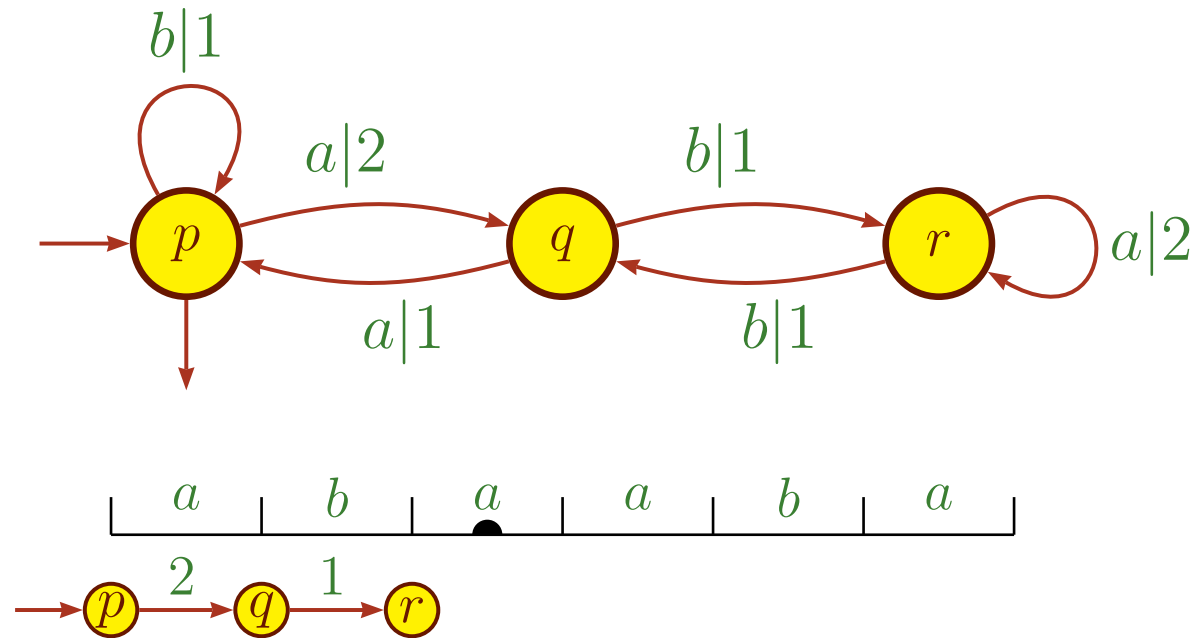

One-way weighted automaton

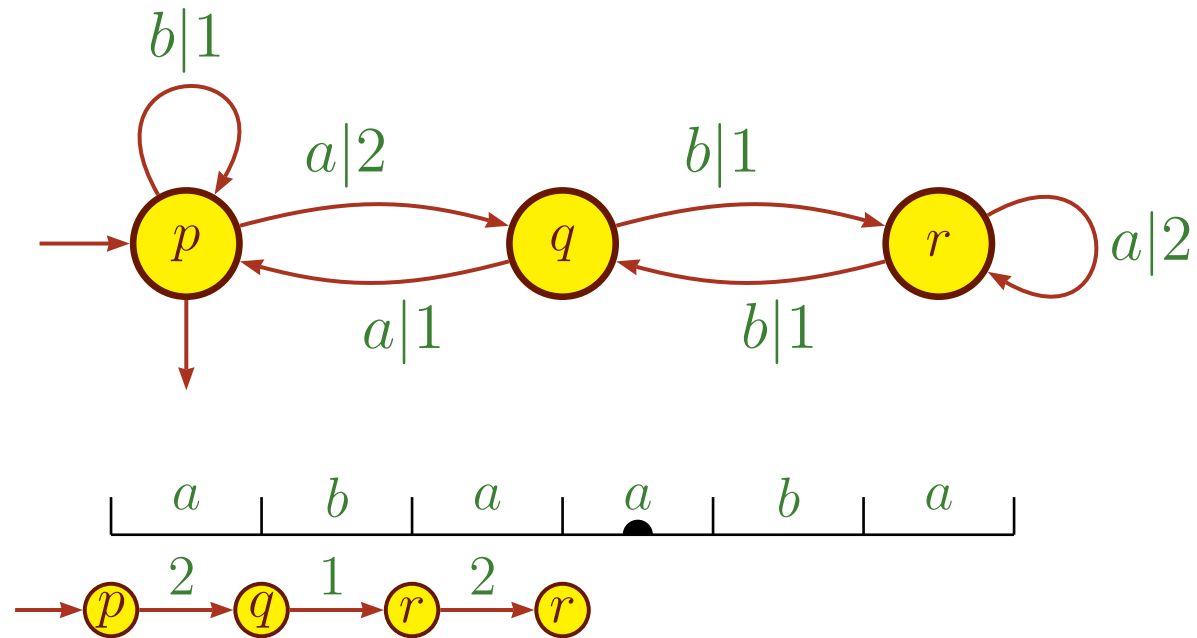

One-way weighted automaton

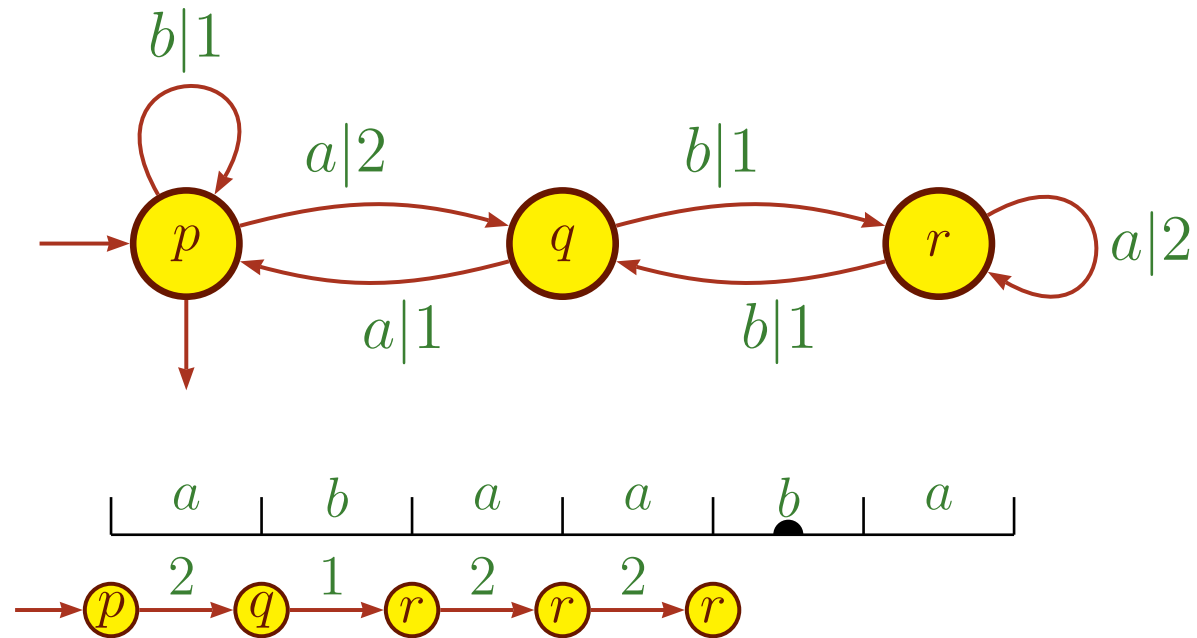

One-way weighted automaton

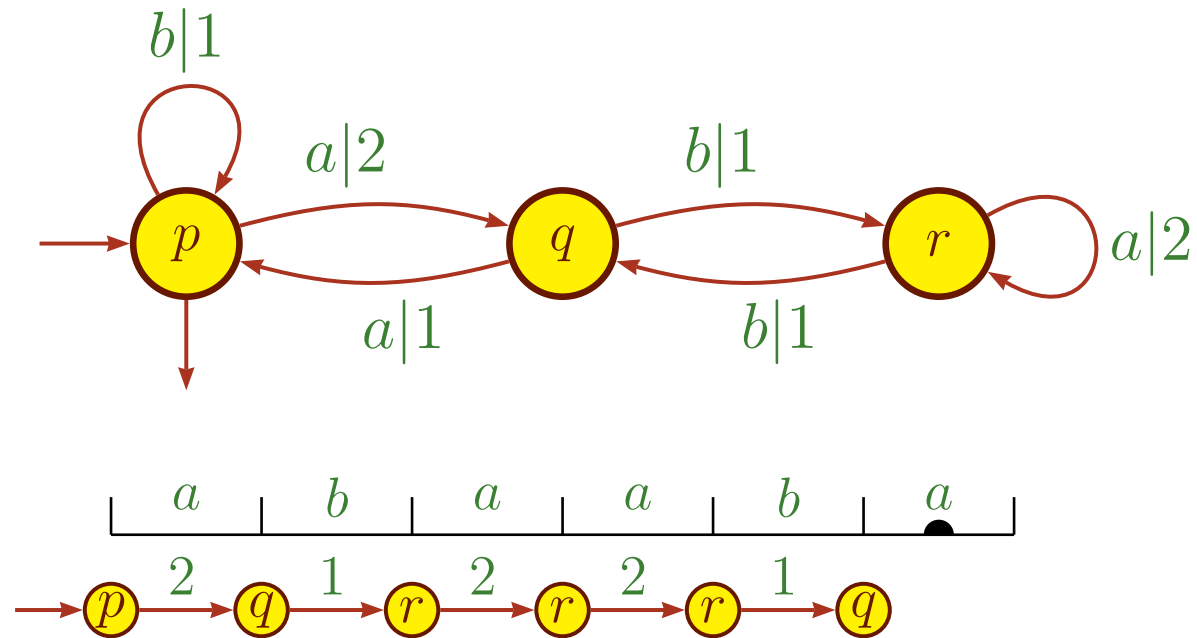

One-way weighted automaton

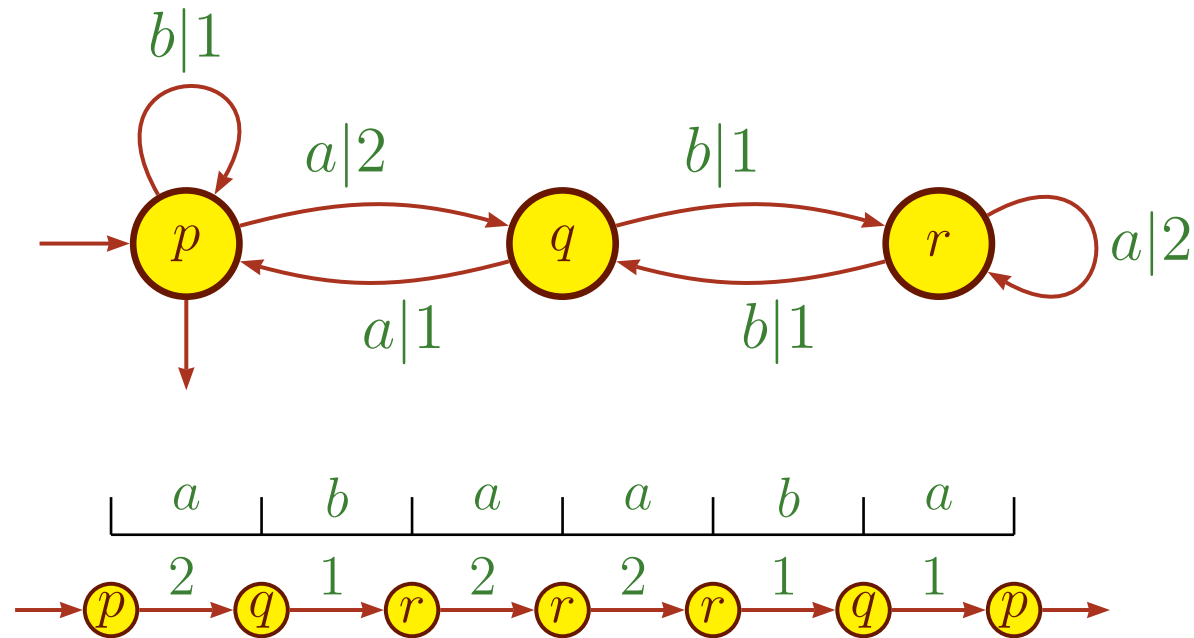

$$\mathcal{A}(abaaba) = 8$$

The automaton realizes a formal power series in $\mathbb{W}\langle\langle A^* \rangle\rangle$.



Linear representation

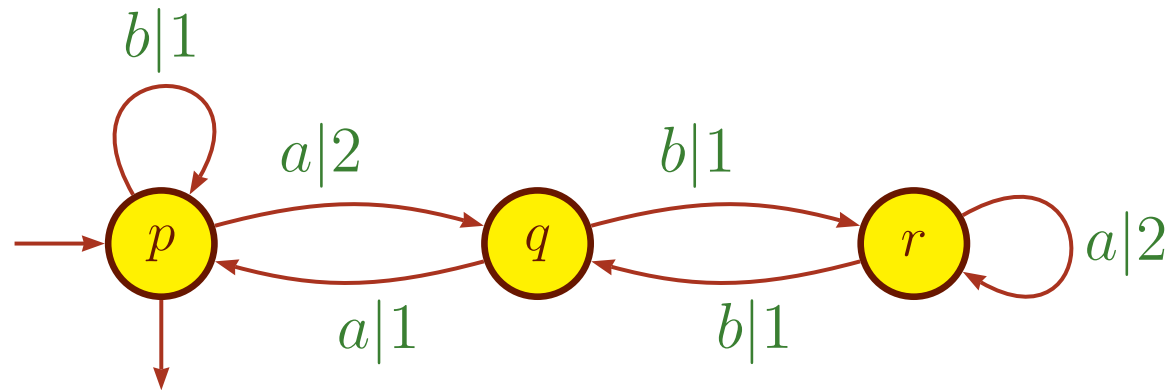

$$I = \begin{bmatrix} 1 & 0 & 0 \end{bmatrix}, \mu(a) = \begin{bmatrix} 0 & 2 & 0 \\ 1 & 0 & 0 \\ 0 & 0 & 2 \end{bmatrix}, \mu(b) = \begin{bmatrix} 1 & 0 & 0 \\ 0 & 0 & 1 \\ 0 & 1 & 0 \end{bmatrix}, T = \begin{bmatrix} 0 \\ 0 \\ 1 \end{bmatrix}$$



Linear representation

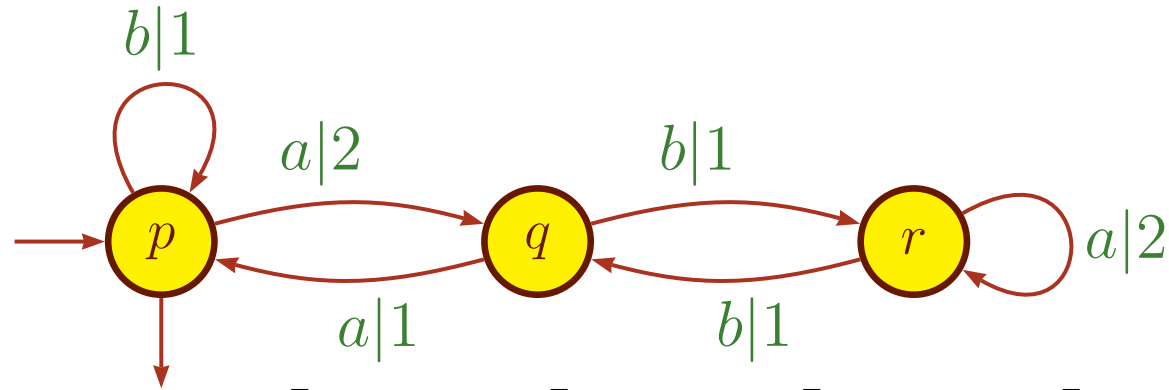

$$I = \begin{bmatrix} 1 & 0 & 0 \end{bmatrix}, \mu(a) = \begin{bmatrix} 0 & 2 & 0 \\ 1 & 0 & 0 \\ 0 & 0 & 2 \end{bmatrix}, \mu(b) = \begin{bmatrix} 1 & 0 & 0 \\ 0 & 0 & 1 \\ 0 & 1 & 0 \end{bmatrix}, T = \begin{bmatrix} 0 \\ 0 \\ 1 \end{bmatrix}$$

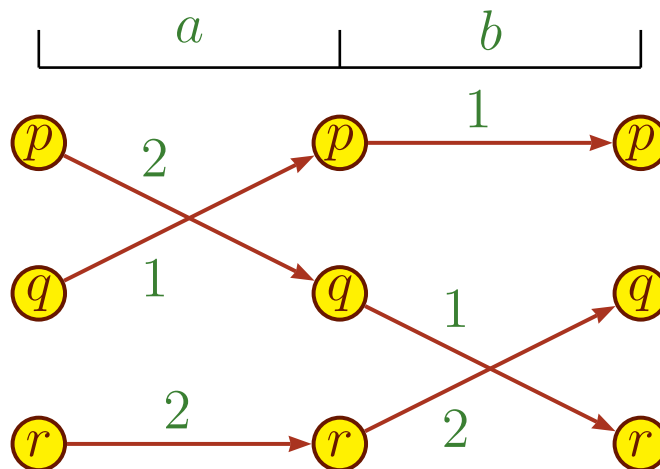

Linear representation

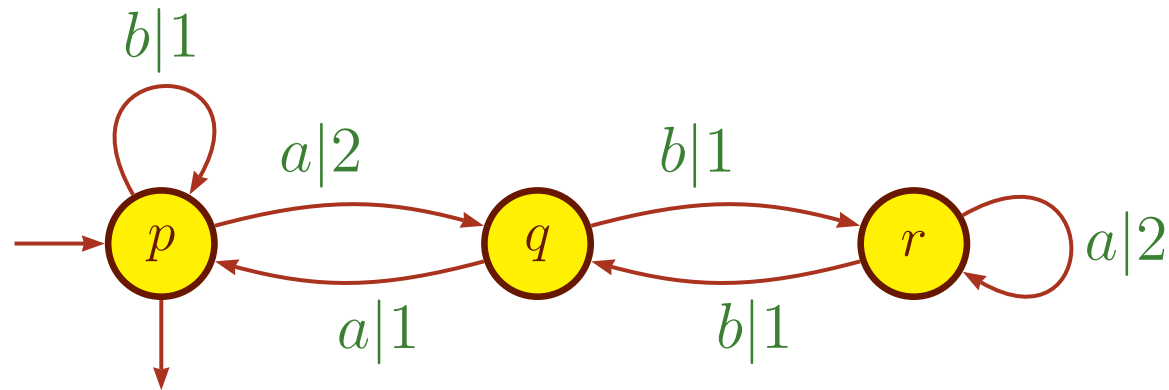

$$I = \begin{bmatrix} 1 & 0 & 0 \end{bmatrix}, \mu(a) = \begin{bmatrix} 0 & 2 & 0 \\ 1 & 0 & 0 \\ 0 & 0 & 2 \end{bmatrix}, \mu(b) = \begin{bmatrix} 1 & 0 & 0 \\ 0 & 0 & 1 \\ 0 & 1 & 0 \end{bmatrix}, T = \begin{bmatrix} 0 \\ 0 \\ 1 \end{bmatrix}$$

$$\mu : A^* \rightarrow \mathbb{W}^{n \times n}$$

$$s_{\mathcal{A}} = \sum_{w \in A^*} (I \mu(w) T) w$$

→ Recognizable series $\mathbb{W}\text{Rec}A^*$



Rational series

Rational operations:

• Sum: $s + t = \sum_{w \in A^*} (\langle s, w \rangle + \langle t, w \rangle) w;$

• Cauchy product: $s \cdot t = \sum_{w \in A^*} \left(\sum_{u.v=w} \langle s, u \rangle \cdot \langle t, v \rangle \right) w;$

• Kleene star:

– s proper $\longrightarrow s^* = \sum_{k=0}^{\infty} s^k,$

– s not proper $\longrightarrow s = s_0 + s_p,$

$$s^* = s_0^* \cdot (s_p \cdot s_0^*)^* \text{ (if } s_0^* \text{ defined).}$$

Rational series $\mathbb{WRat}A^* = \langle \mathbb{WPol}A^* \rangle_{+, \cdot, *}$



Fixed-point equation

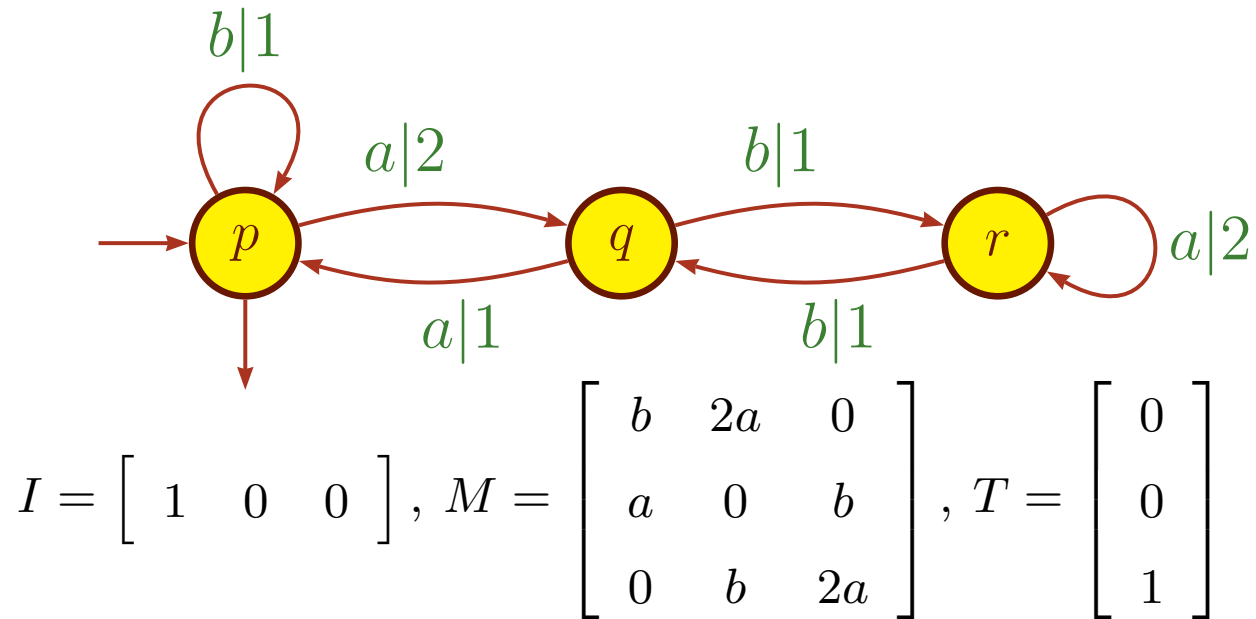

Fixed-point equation

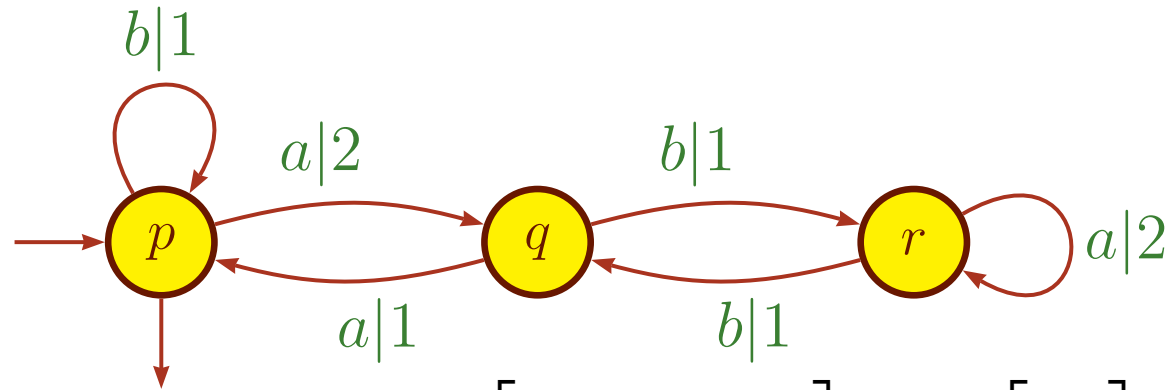

$$I = \begin{bmatrix} 1 & 0 & 0 \end{bmatrix}, M = \begin{bmatrix} b & 2a & 0 \\ a & 0 & b \\ 0 & b & 2a \end{bmatrix}, T = \begin{bmatrix} 0 \\ 0 \\ 1 \end{bmatrix}$$

$X \in \mathbb{W}\langle\langle A^* \rangle\rangle$: X_p series realized when p is the initial state:



Fixed-point equation

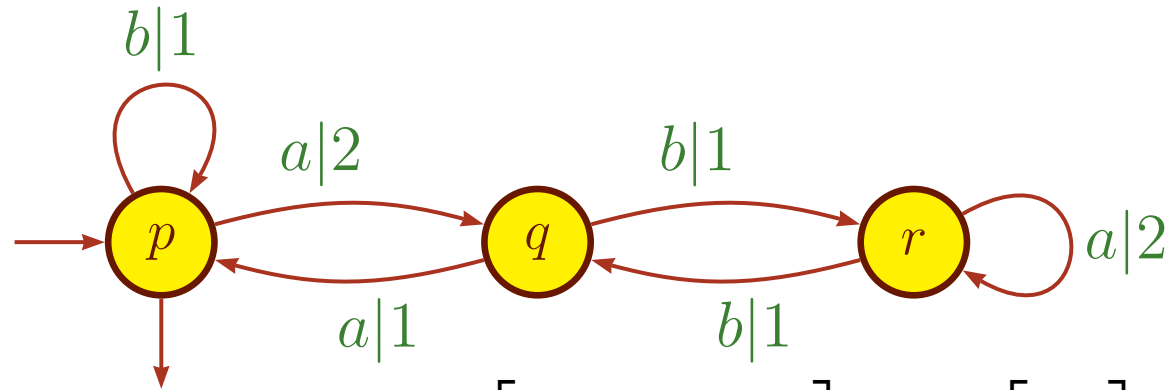

$$I = \begin{bmatrix} 1 & 0 & 0 \end{bmatrix}, M = \begin{bmatrix} b & 2a & 0 \\ a & 0 & b \\ 0 & b & 2a \end{bmatrix}, T = \begin{bmatrix} 0 \\ 0 \\ 1 \end{bmatrix}$$

$X \in \mathbb{W}(\langle\langle A^* \rangle\rangle) : X_p$ series realized when p is the initial state:

$$X_p = T_p + \sum_{q:\text{state}} M_{p,q} T_q + \dots$$



Fixed-point equation

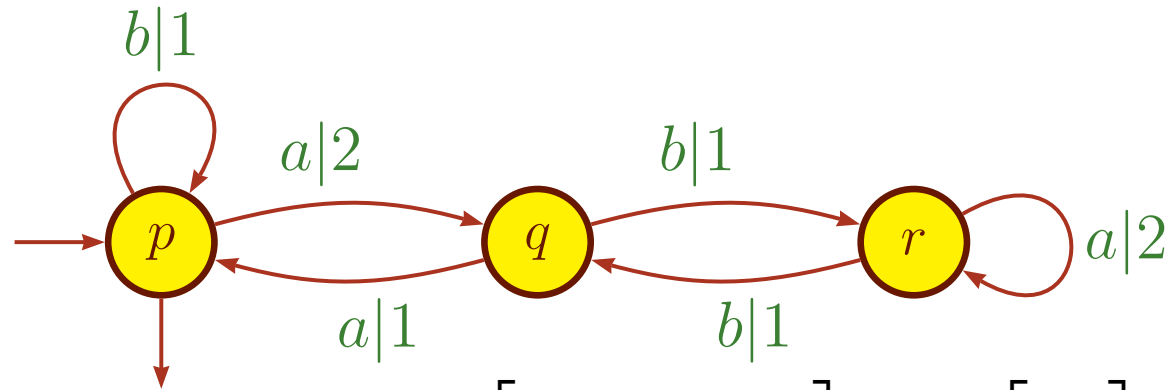

$$I = \begin{bmatrix} 1 & 0 & 0 \end{bmatrix}, M = \begin{bmatrix} b & 2a & 0 \\ a & 0 & b \\ 0 & b & 2a \end{bmatrix}, T = \begin{bmatrix} 0 \\ 0 \\ 1 \end{bmatrix}$$

$X \in \mathbb{W}\langle\langle A^* \rangle\rangle$: X_p series realized when p is the initial state:

$$X_p = T_p + \sum_{q:\text{state}} M_{p,q} X_q$$



Fixed-point equation

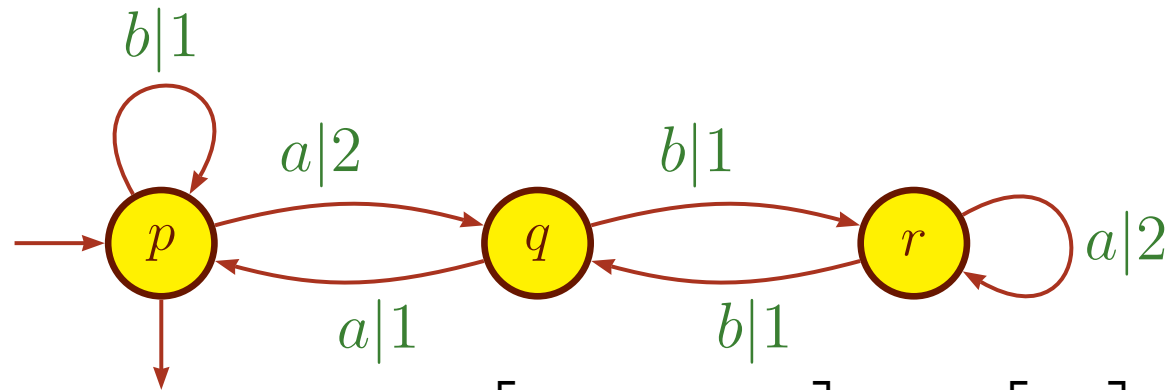

$$I = \begin{bmatrix} 1 & 0 & 0 \end{bmatrix}, M = \begin{bmatrix} b & 2a & 0 \\ a & 0 & b \\ 0 & b & 2a \end{bmatrix}, T = \begin{bmatrix} 0 \\ 0 \\ 1 \end{bmatrix}$$

$X \in \mathbb{W}\langle\langle A^* \rangle\rangle$: X_p series realized when p is the initial state:

$$X = T + M.X$$



Fixed-point equation

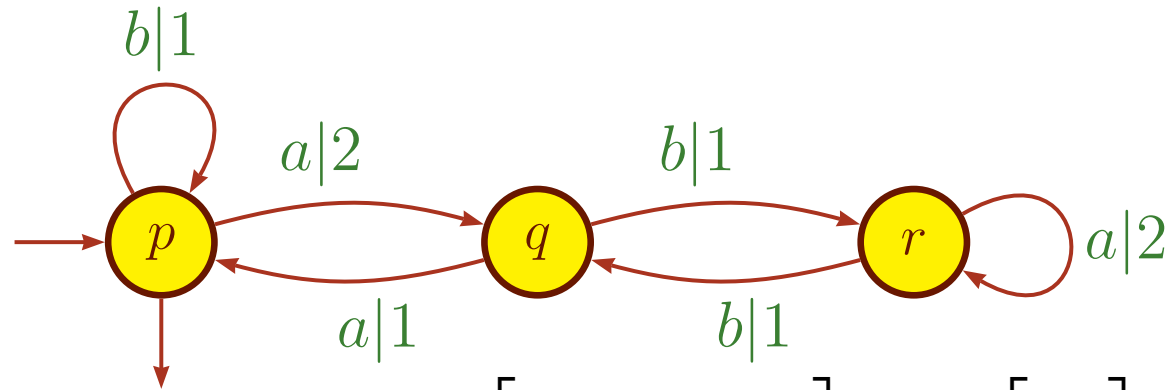

$$I = \begin{bmatrix} 1 & 0 & 0 \end{bmatrix}, M = \begin{bmatrix} b & 2a & 0 \\ a & 0 & b \\ 0 & b & 2a \end{bmatrix}, T = \begin{bmatrix} 0 \\ 0 \\ 1 \end{bmatrix}$$

$X \in \mathbb{W}\langle\langle A^* \rangle\rangle$: X_p series realized when p is the initial state:

$$X = T + M.X$$

This can be solved in the semiring of rational series $\mathbb{WRat}A^*$:

$$s_{\mathcal{A}} = I.X = I.M^*.T = (b + 2a(b(2a)^*b)^*a)^*$$



Fixed-point equation

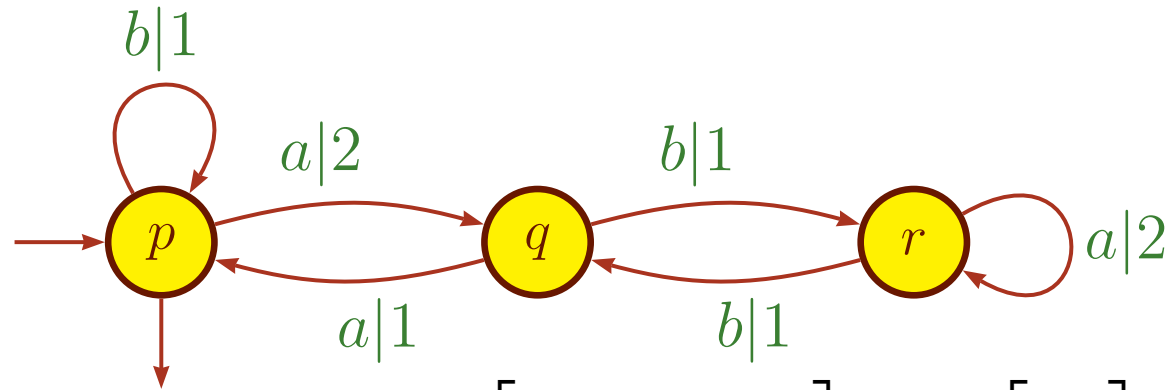

$$I = \begin{bmatrix} 1 & 0 & 0 \end{bmatrix}, M = \begin{bmatrix} b & 2a & 0 \\ a & 0 & b \\ 0 & b & 2a \end{bmatrix}, T = \begin{bmatrix} 0 \\ 0 \\ 1 \end{bmatrix}$$

$X \in \mathbb{W}\langle\langle A^* \rangle\rangle$: X_p series realized when p is the initial state:

$$X = T + M.X$$

This can be solved in the semiring of rational series $\mathbb{WRat}A^*$:

$$\longrightarrow \mathbb{WRec}A^* \subseteq \mathbb{WRat}A^*$$



Finally...

Recognizable series are closed under rational operations, so...



Finally...

Recognizable series are closed under rational operations, so...

Kleene-Schützenberger Theorem :

$$\mathbb{W}\text{Rat}A^* = \mathbb{W}\text{Rec}A^*$$



Two-way Weighted Automaton

I. Automata



Two-way Weighted Automaton

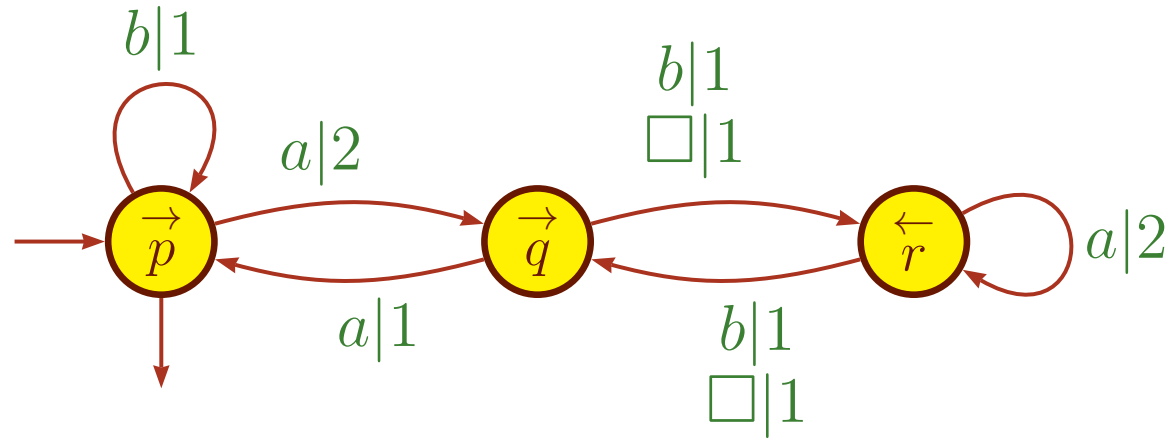

Two-way Weighted Automaton

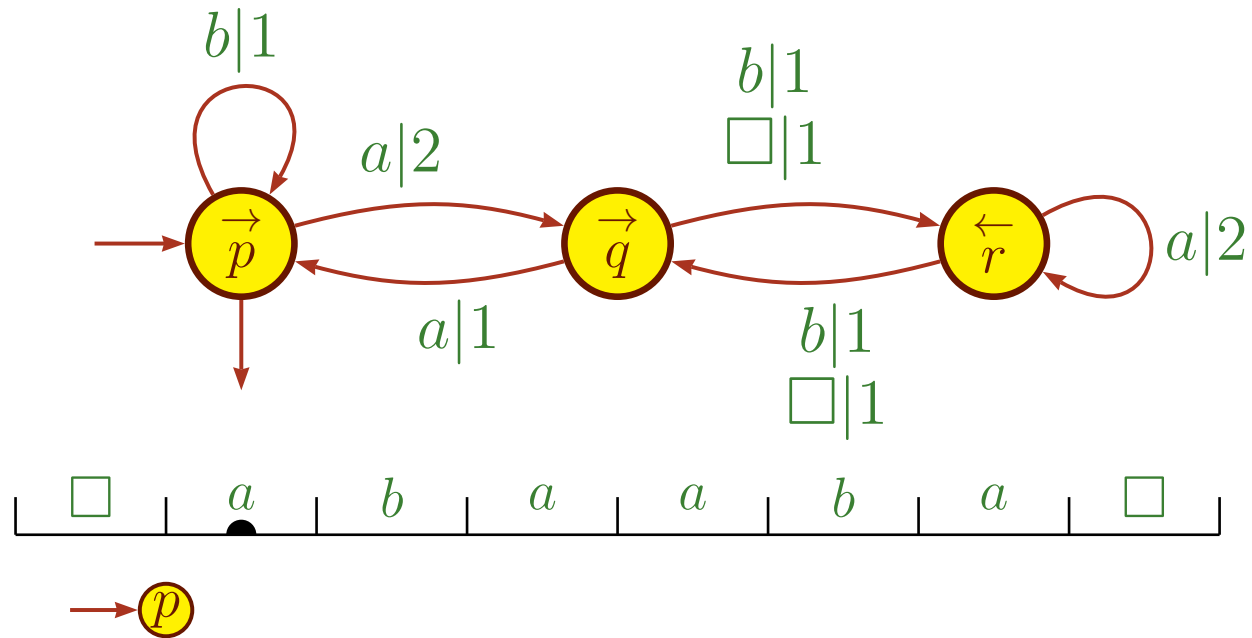

Two-way Weighted Automaton

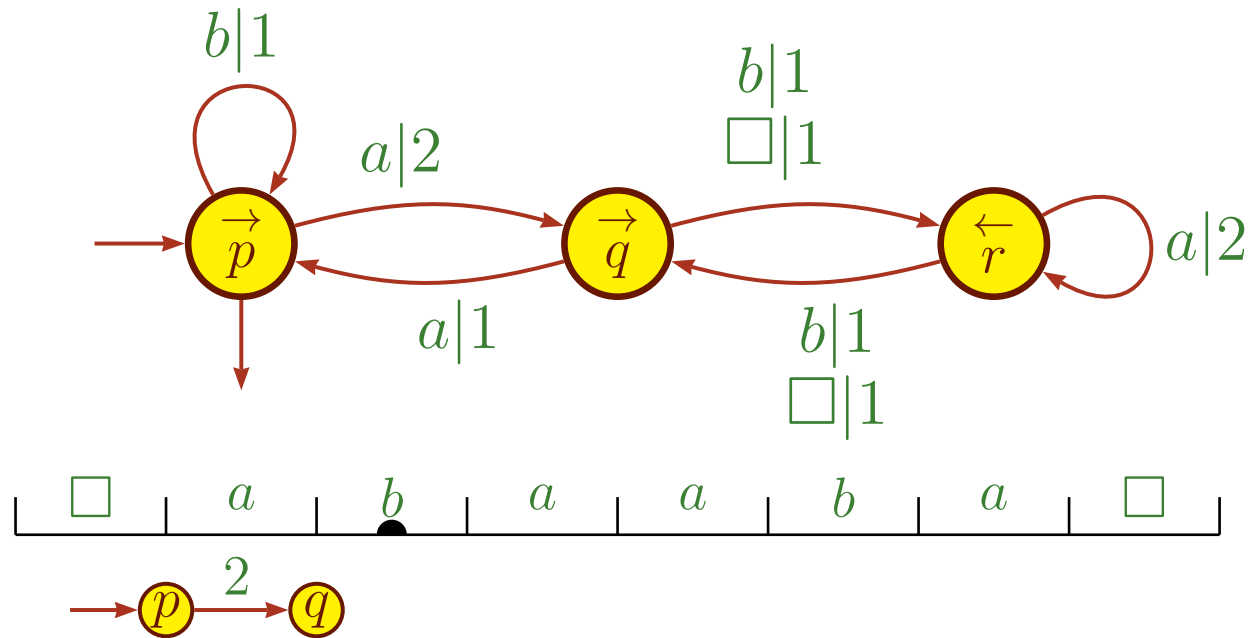

Two-way Weighted Automaton

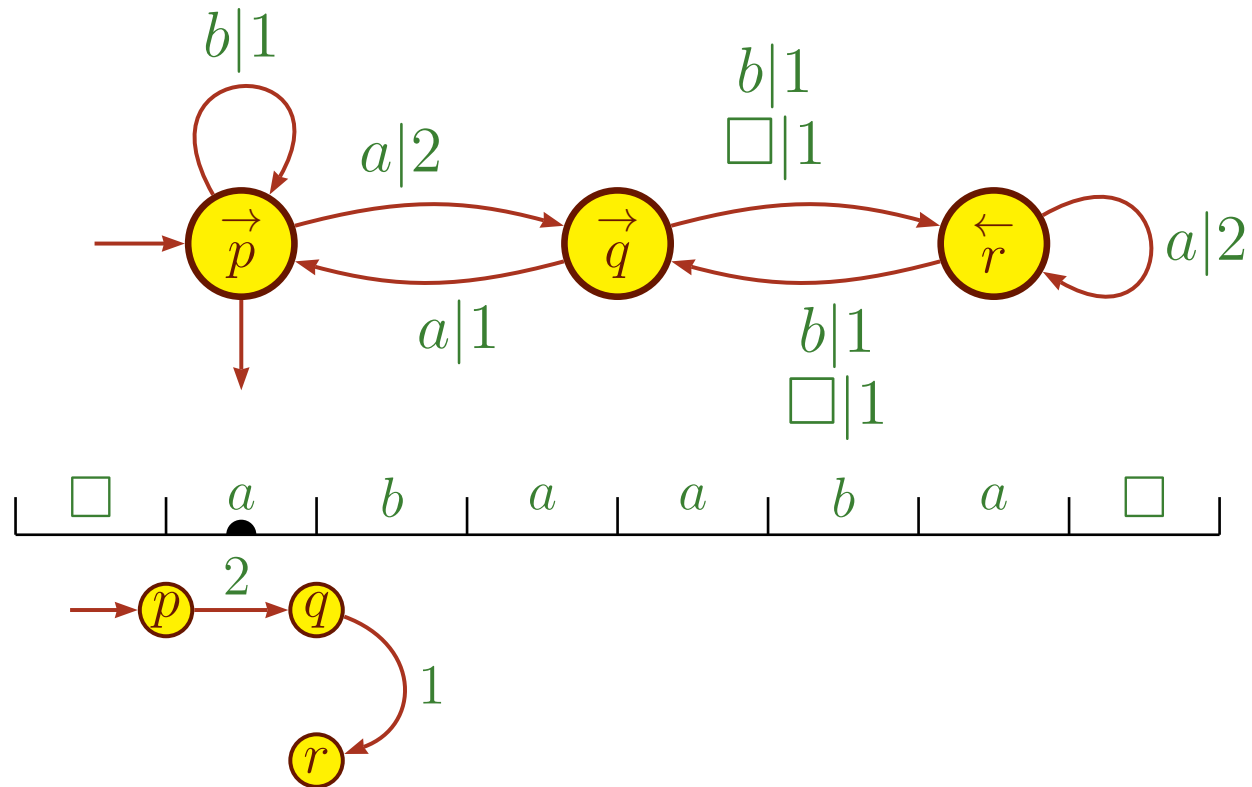

Two-way Weighted Automaton

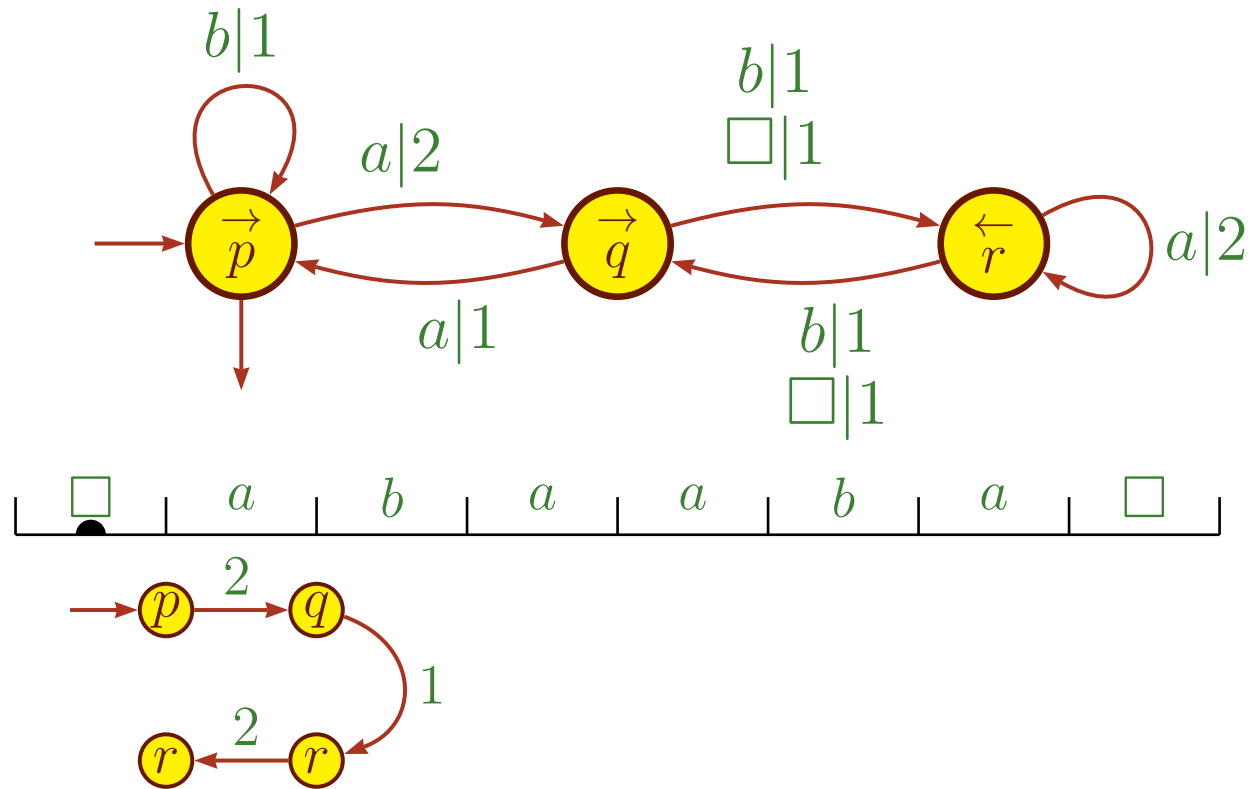

Two-way Weighted Automaton

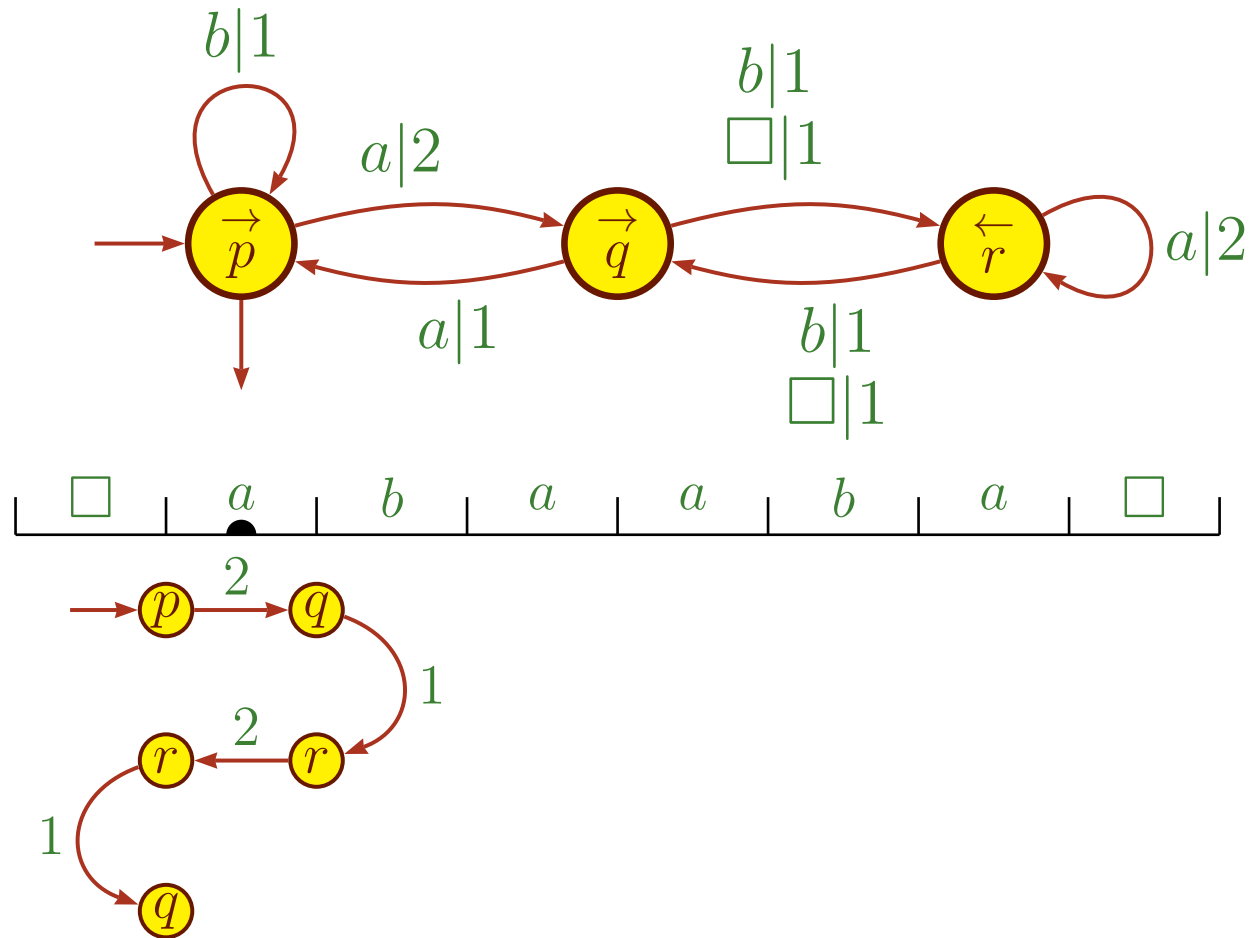

Two-way Weighted Automaton

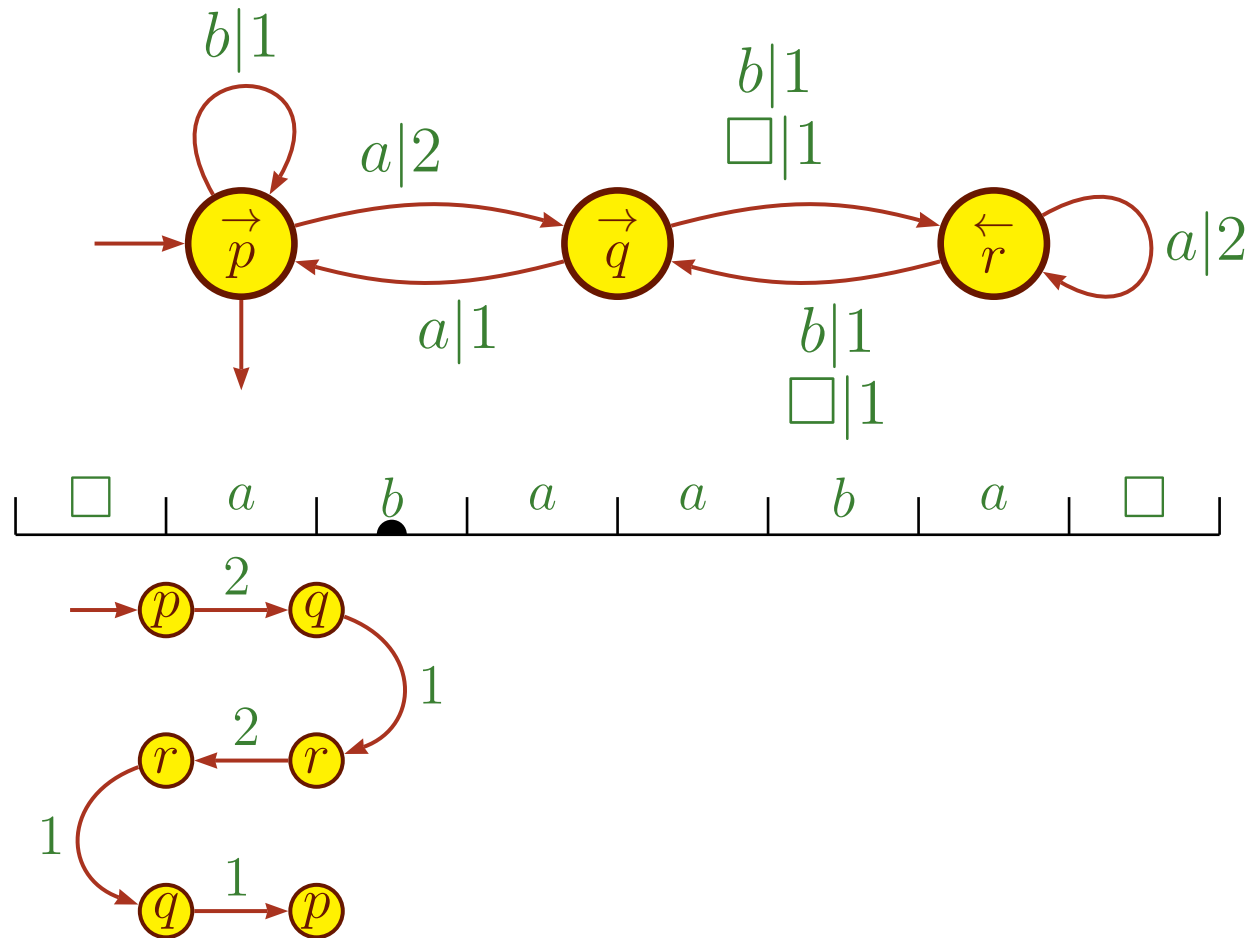

Two-way Weighted Automaton

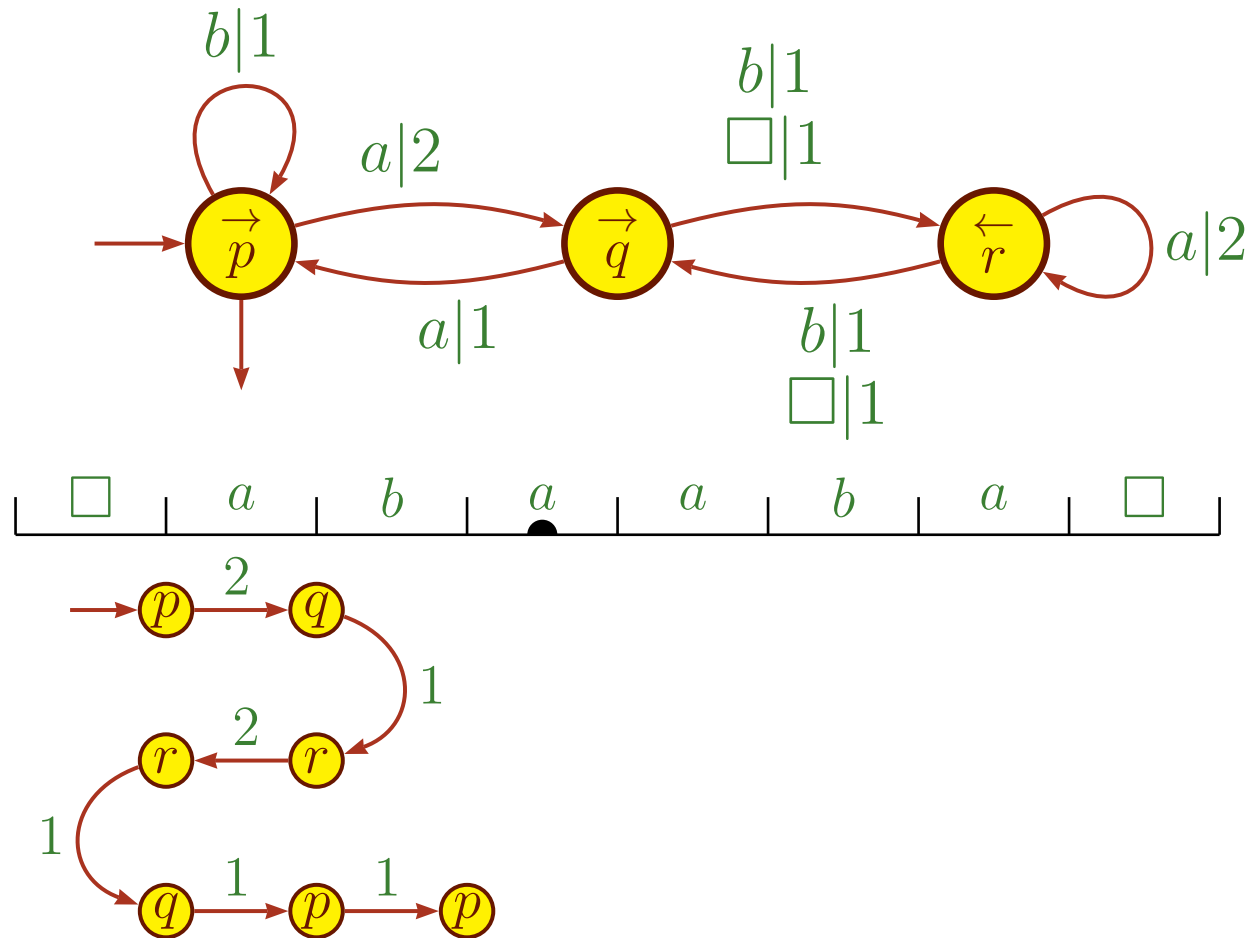

Two-way Weighted Automaton

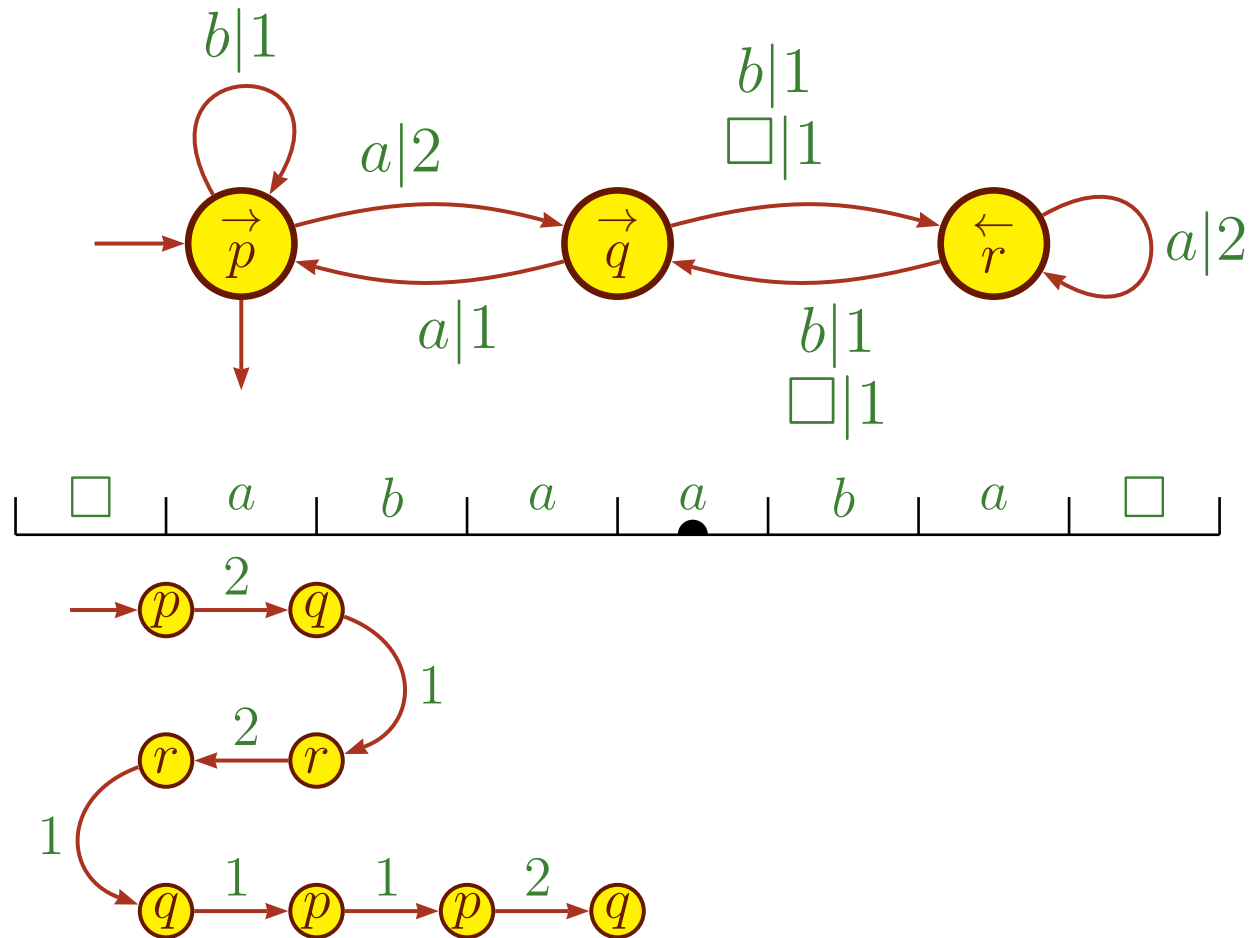

Two-way Weighted Automaton

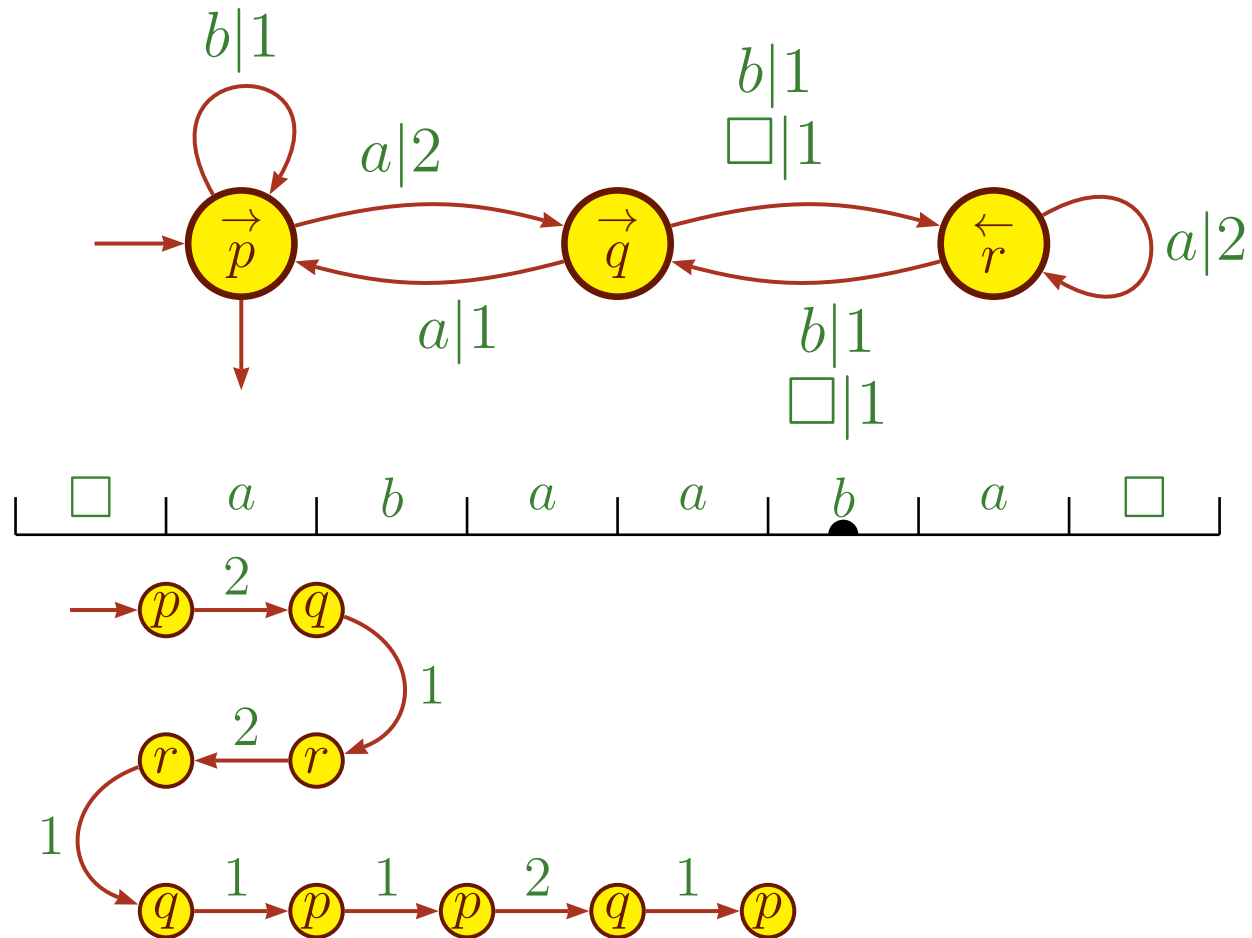

Two-way Weighted Automaton

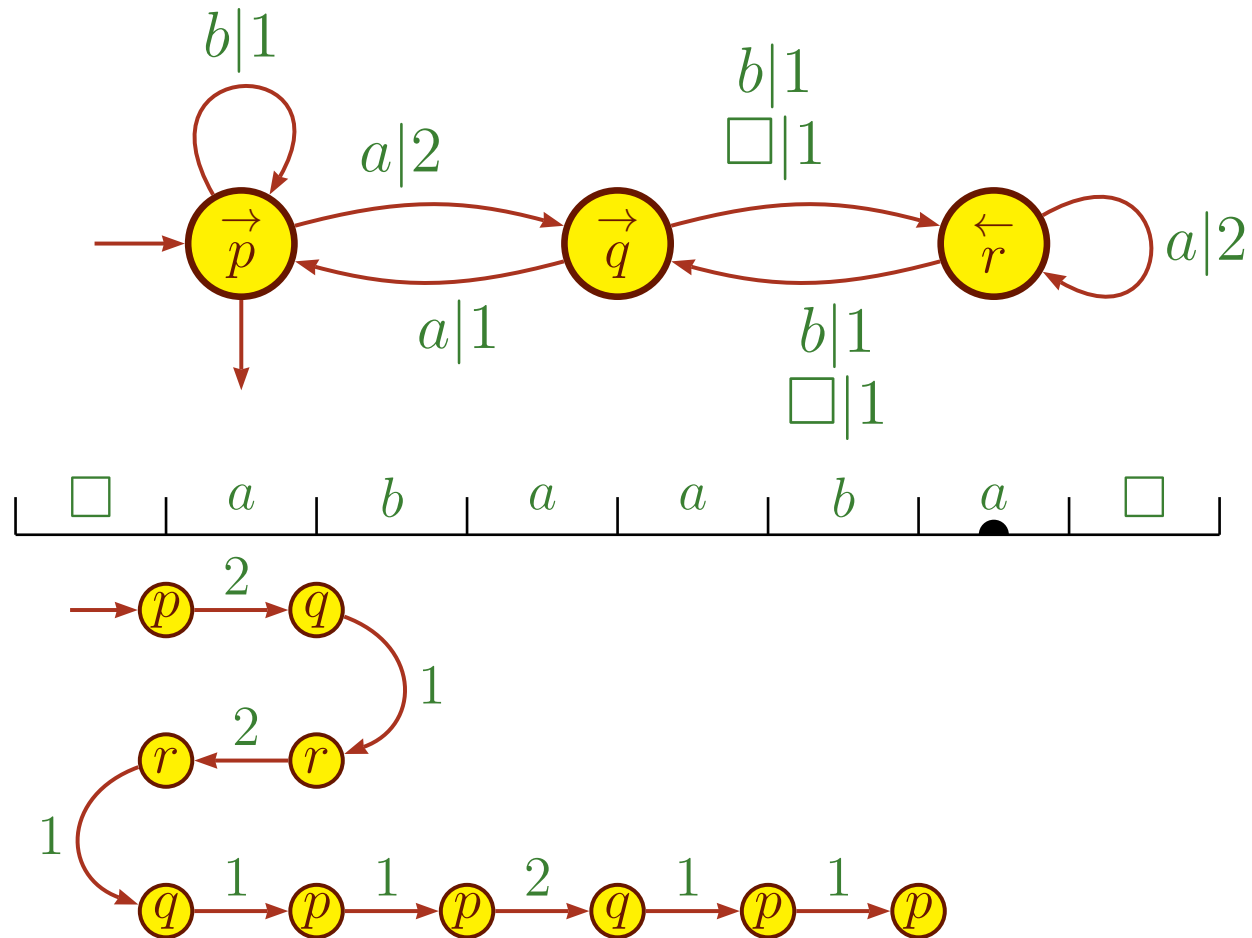

Two-way Weighted Automaton

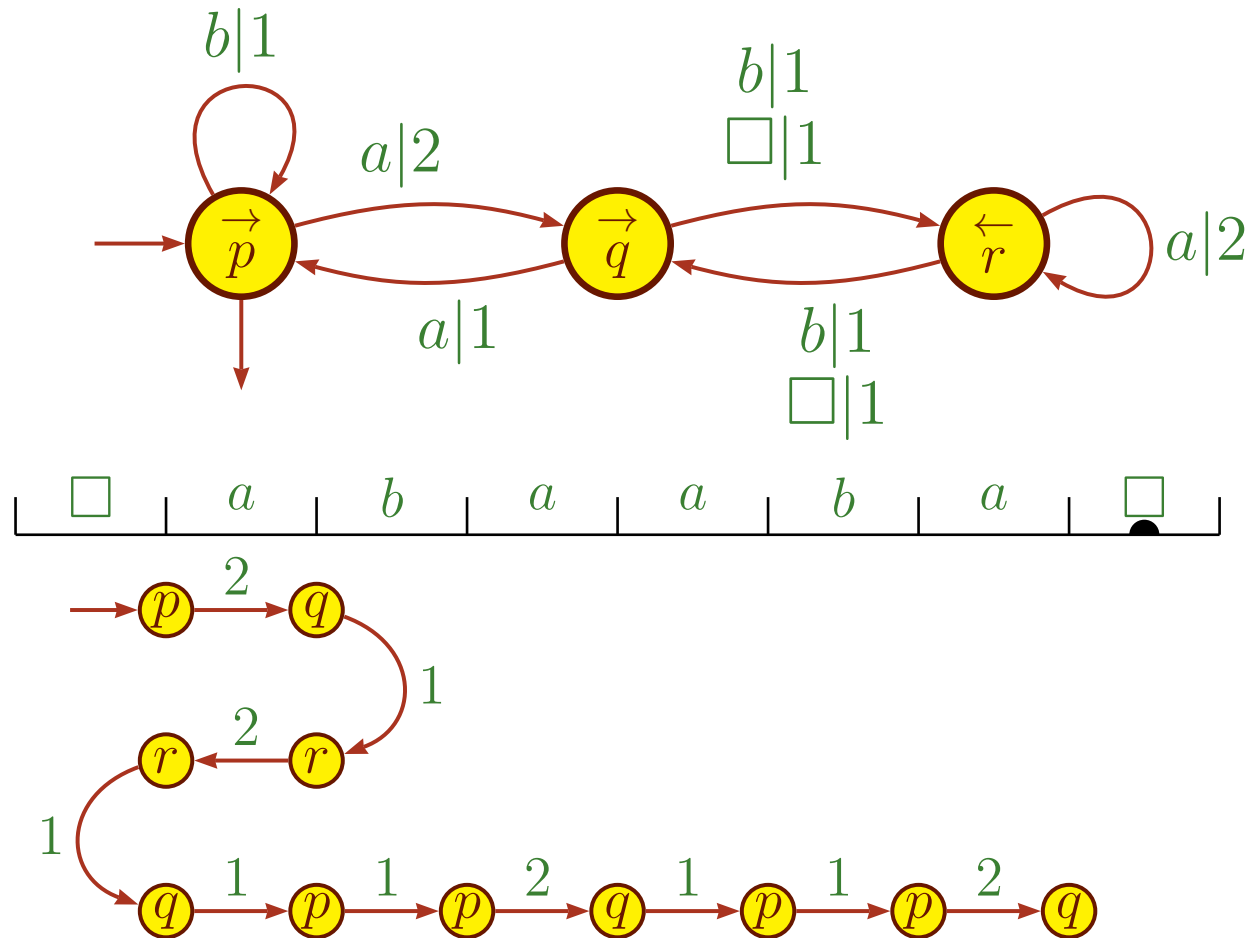

Two-way Weighted Automaton

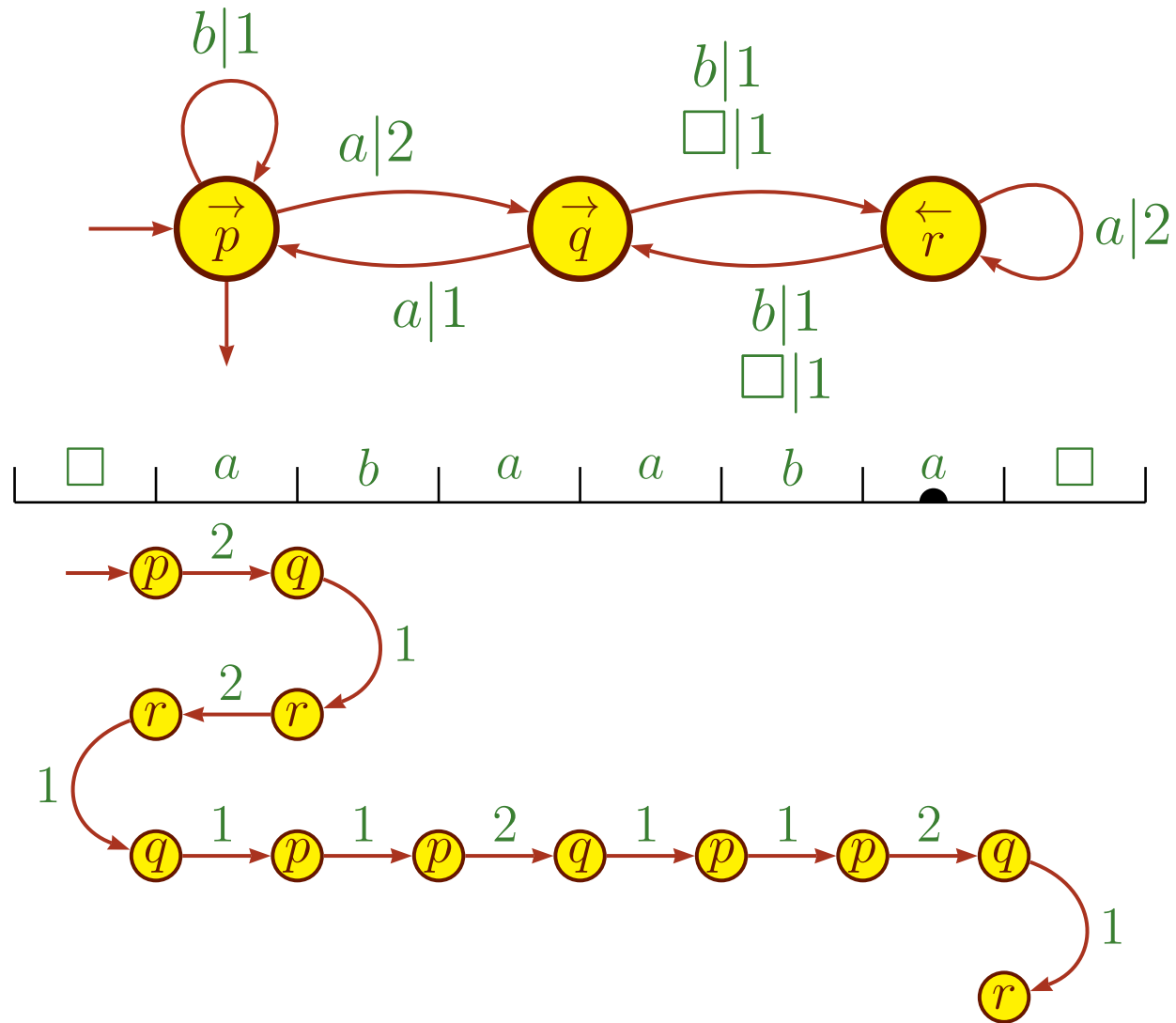

Two-way Weighted Automaton

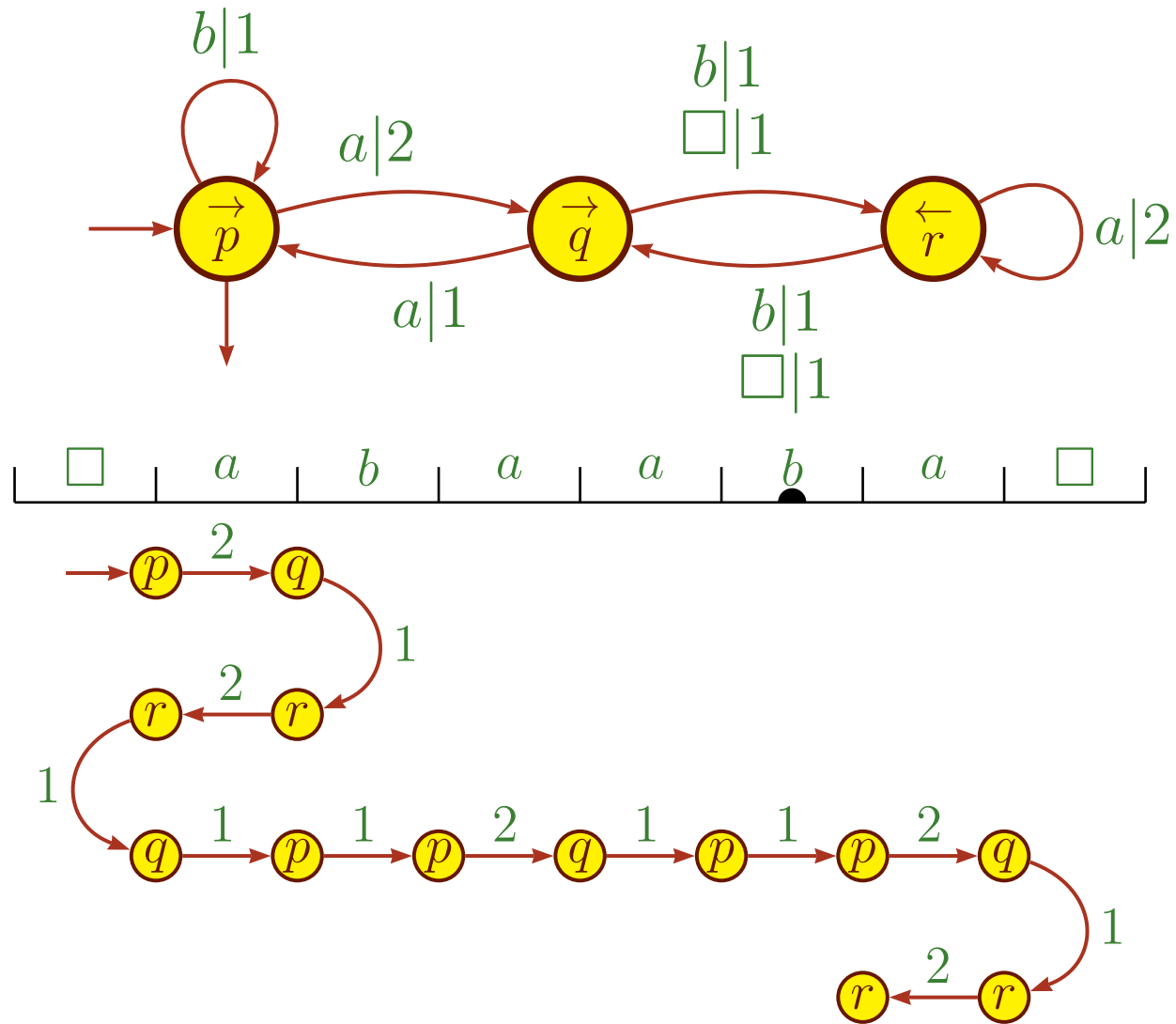

Two-way Weighted Automaton

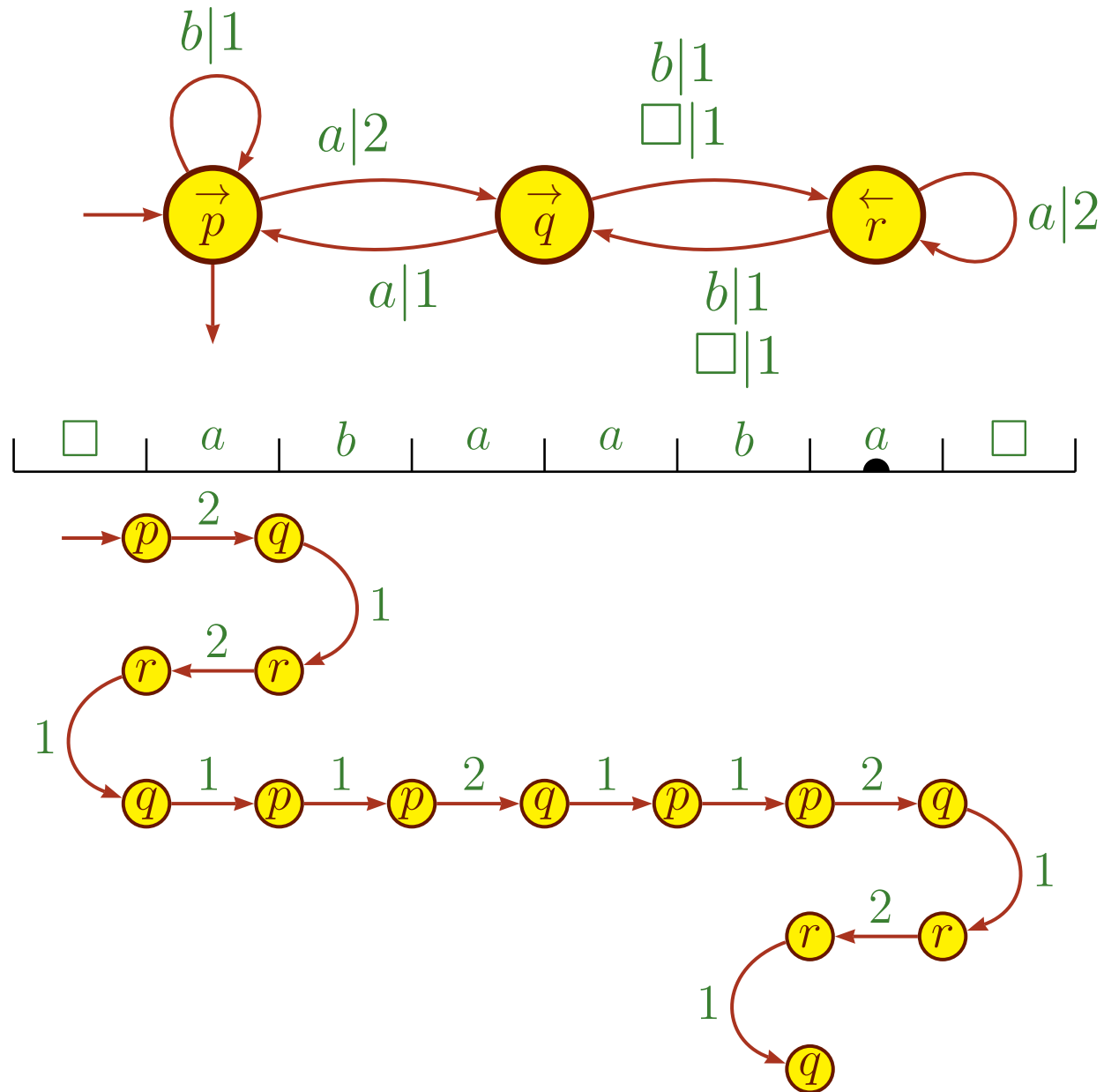

Two-way Weighted Automaton

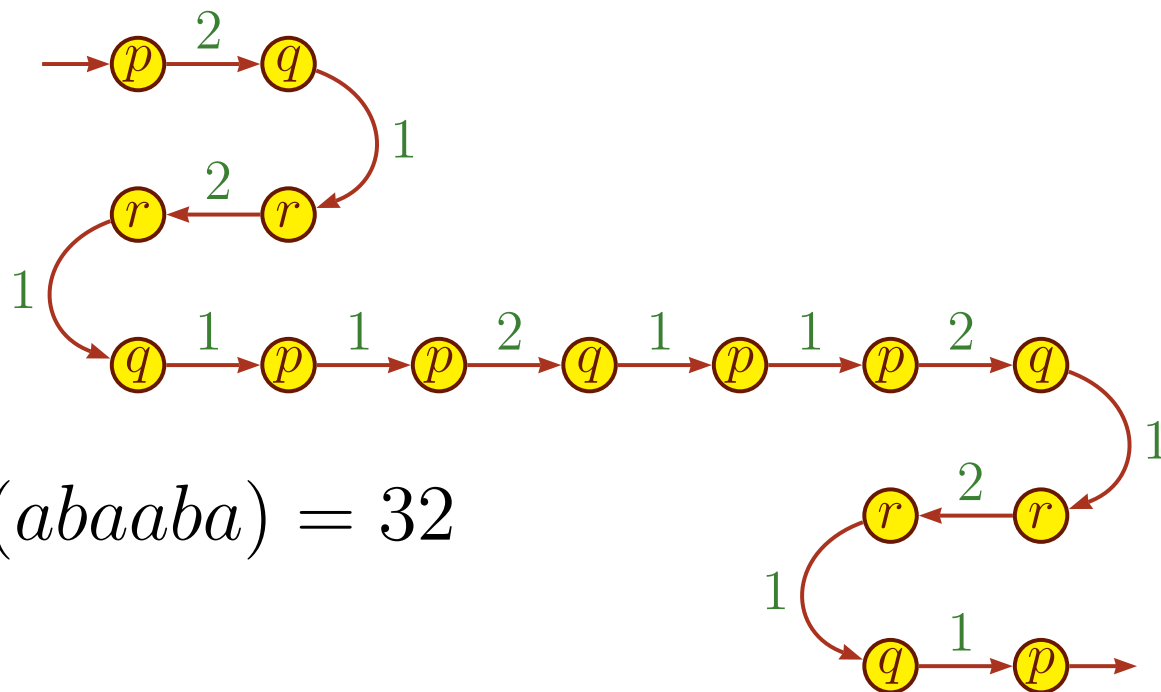
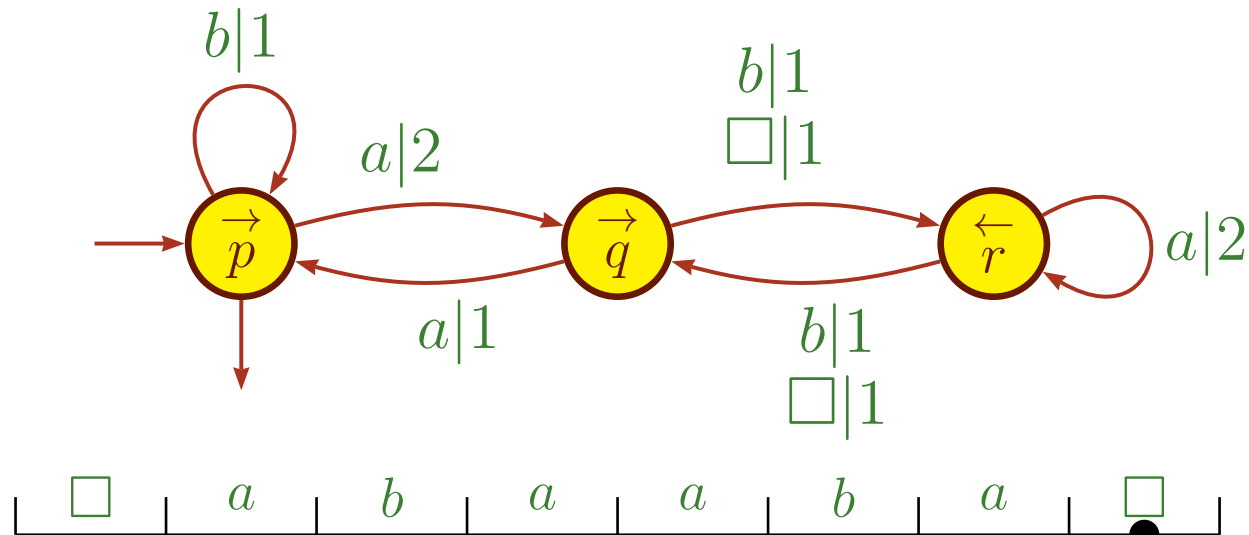

$$\mathcal{A}(abaaba) = 32$$



Two-way Weighted Automaton

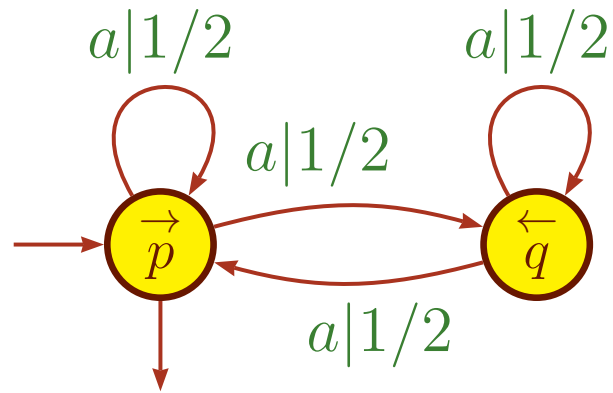

Two-way Weighted Automaton

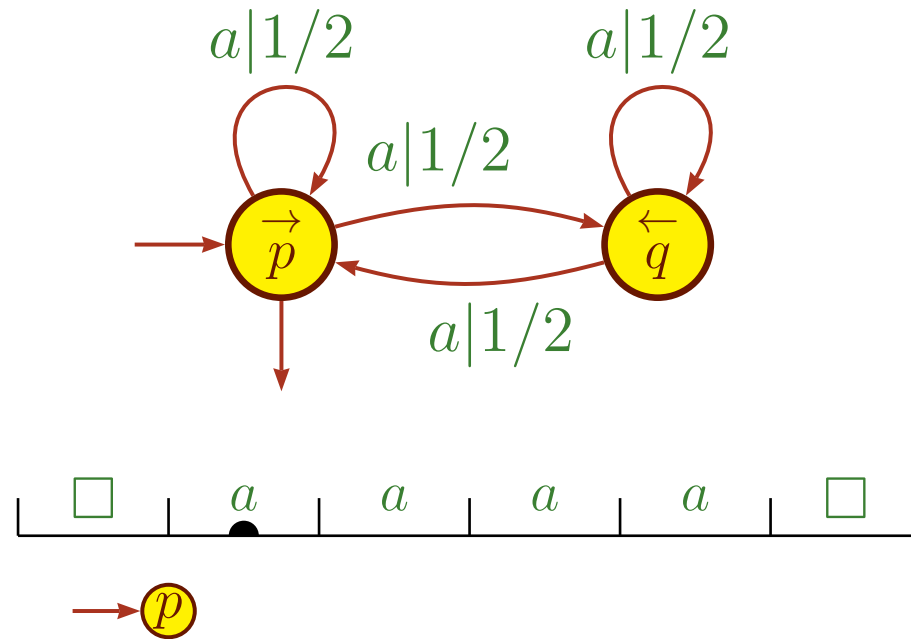

Two-way Weighted Automaton

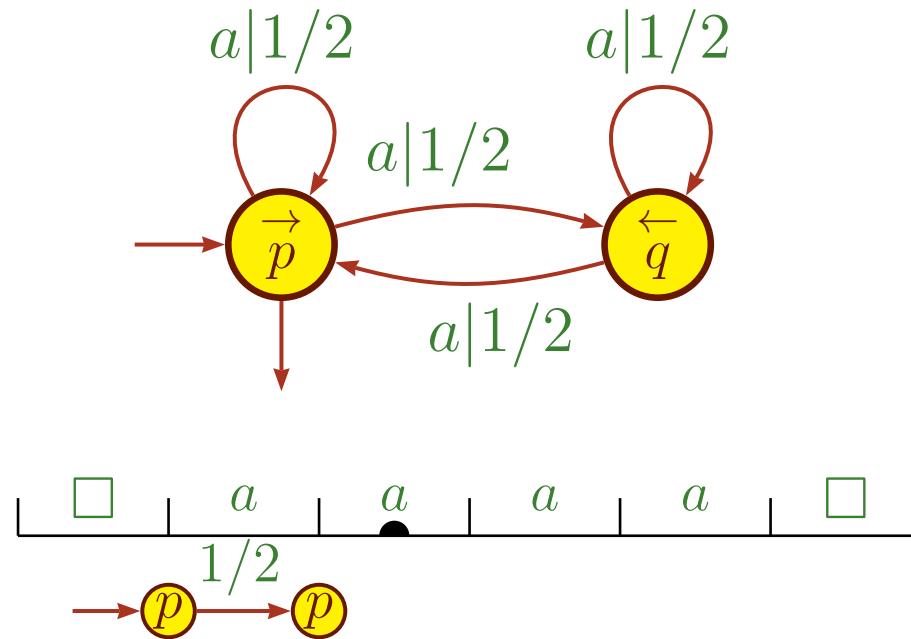

Two-way Weighted Automaton

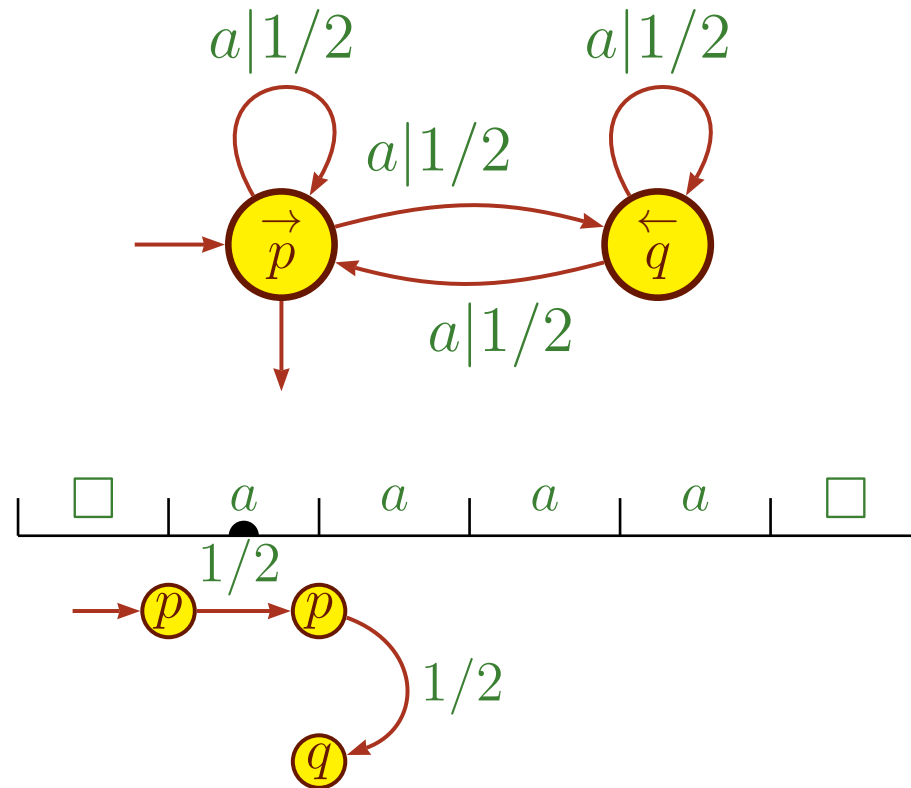

Two-way Weighted Automaton

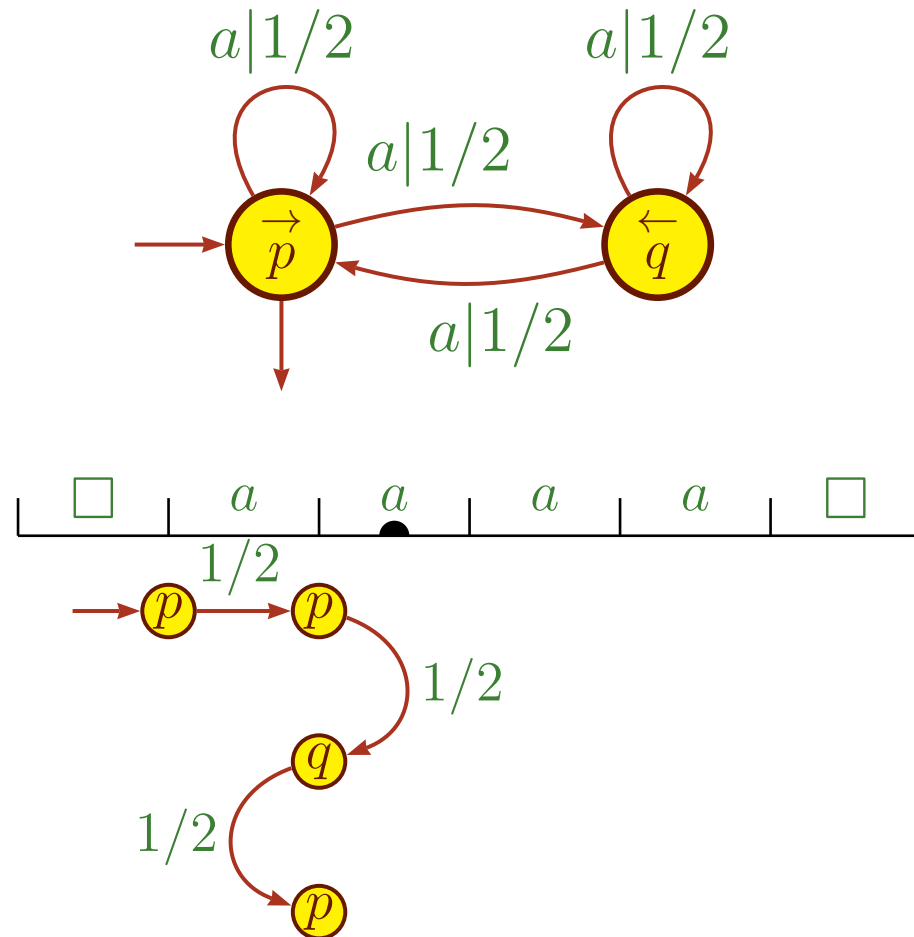

Two-way Weighted Automaton

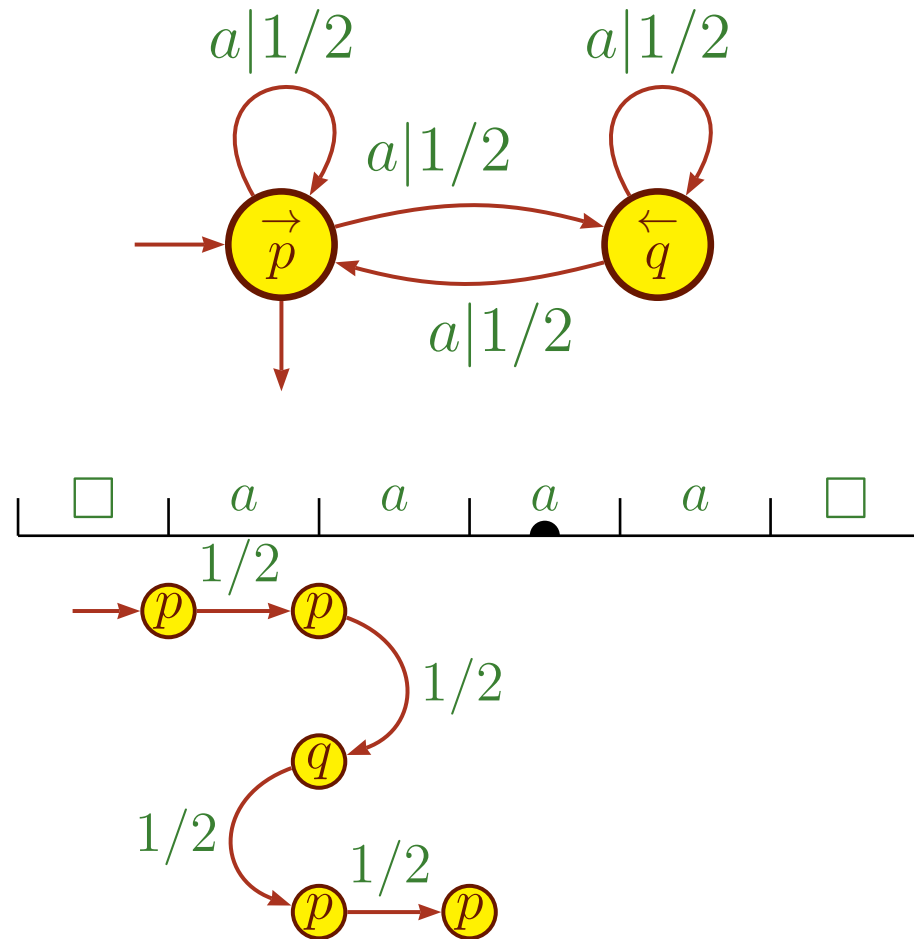

Two-way Weighted Automaton

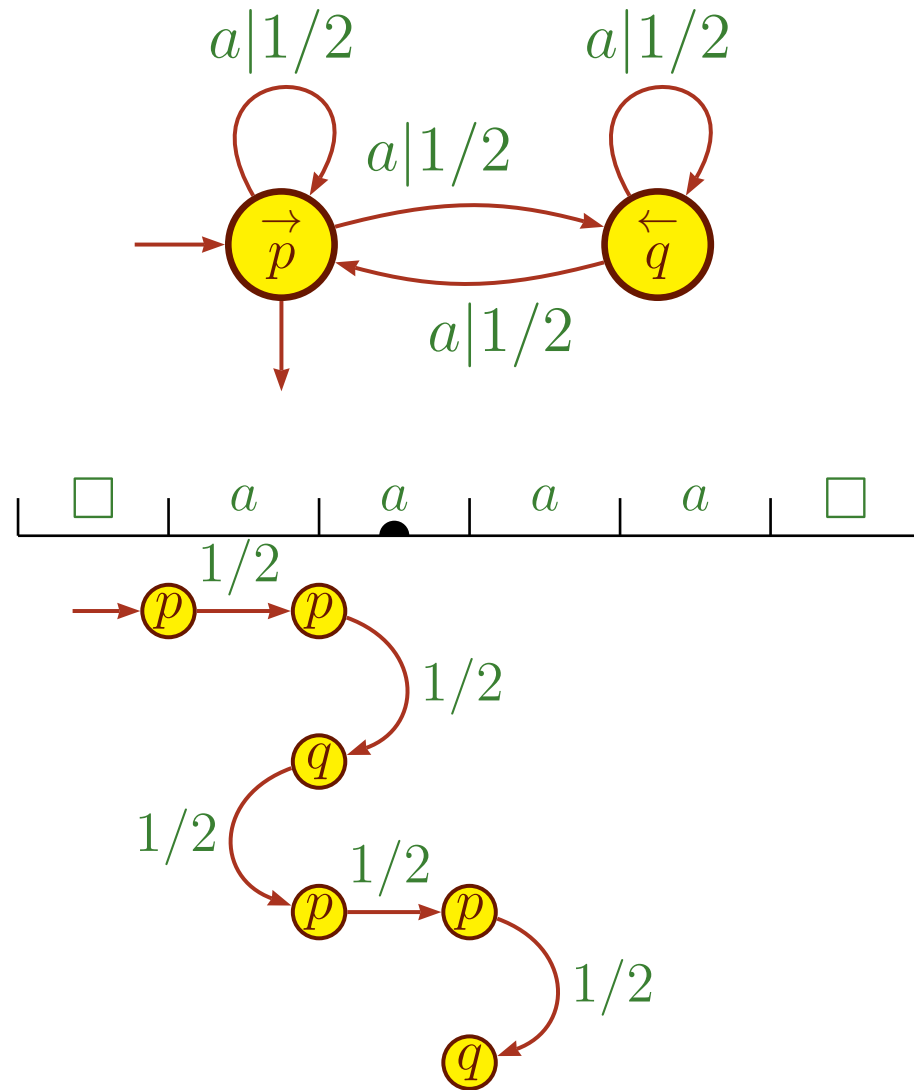

Two-way Weighted Automaton

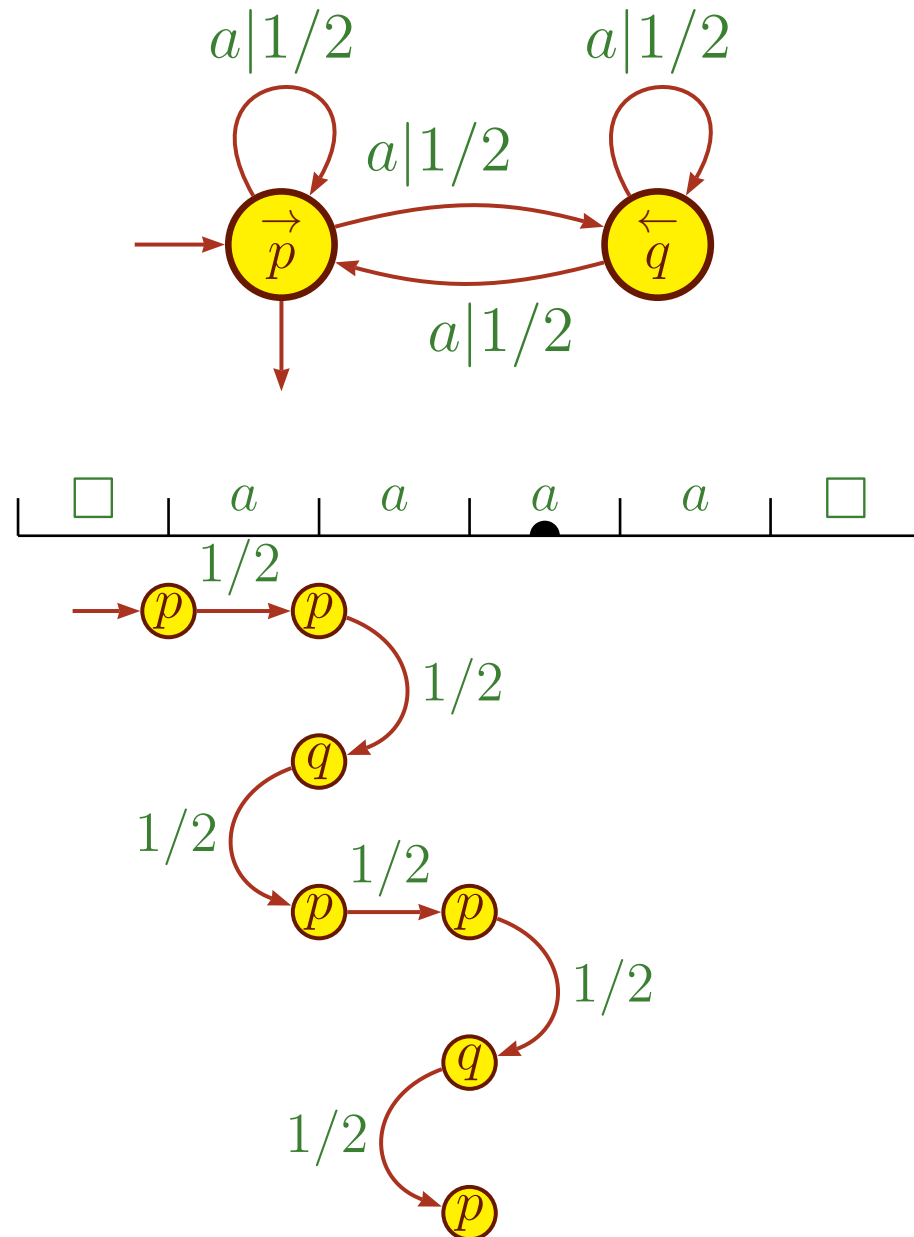

Two-way Weighted Automaton

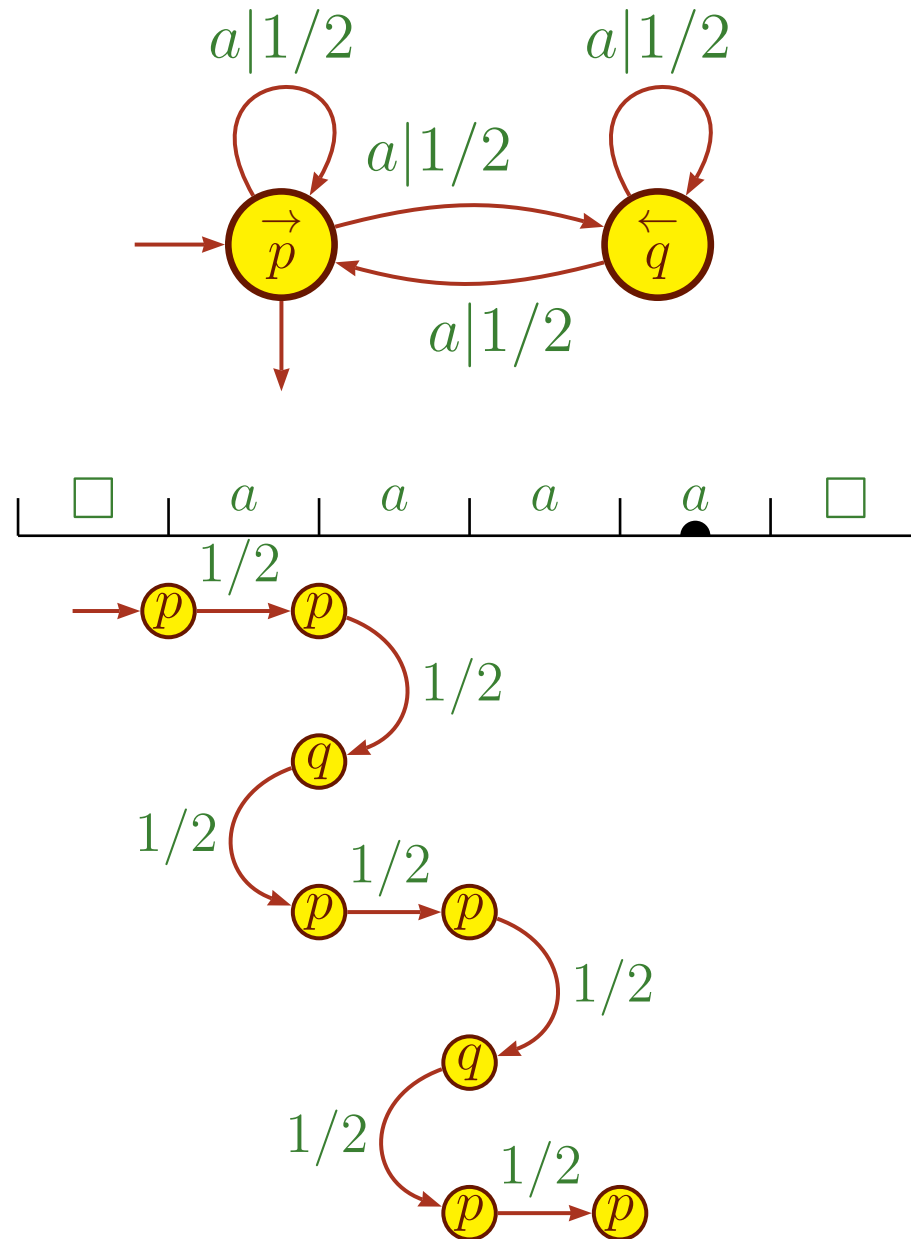

Two-way Weighted Automaton

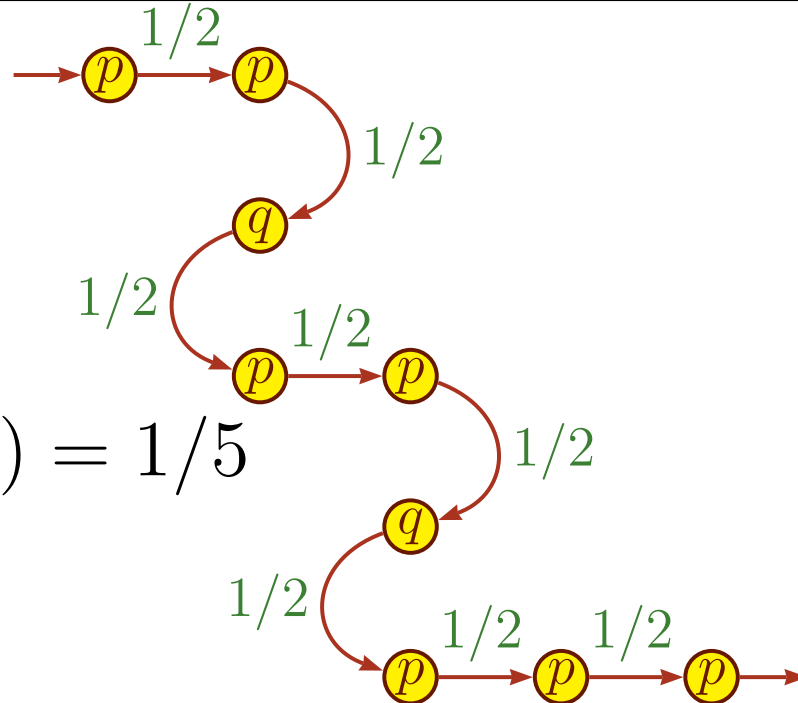
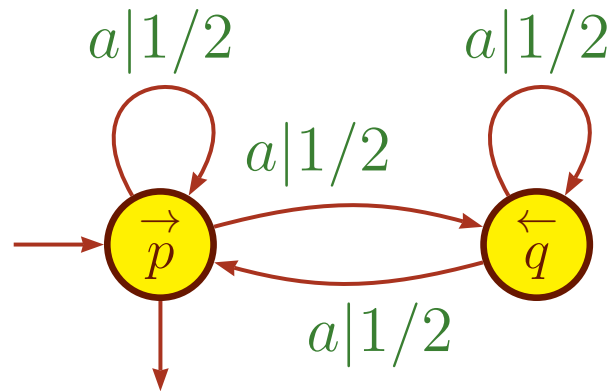

$$\mathcal{A}(aaaa) = 1/5$$



Two-way Weighted Automaton

An automaton is **valid** if the weight of every word is defined.



Classes of two-way weighted automata

A two-way weighted automaton is

- **sweeping** if every half-turn transition is labeled by \square ;
- **rotating** if it is sweeping and every backward state is a "rewind";
- **one-way** if there is no backward state;
- **simple** if the number of computations is finite for each input.



Simple automata

Proposition It is decidable whether a two-way automaton is simple.

Theorem[Anselmo, 90] \mathcal{A} two-way \mathbb{W} -automaton

\mathcal{A} simple and \mathbb{W} commutative $\implies \mathcal{A}$ equivalent to a one-way.

Proposition \mathcal{A} two-way \mathbb{W} -automaton

• $\mathbb{W} = \mathbb{Z} : \mathcal{A}$ valid $\iff \mathcal{A}$ simple.

• $\mathbb{W} = \mathbb{Q} : \text{Validity of } \mathcal{A} \text{ is undecidable.}$



Rationally Additive Semirings [Ésik & Kuich, 02]

\mathbb{W} is rationally additive if for every x in \mathbb{W} ,

$$\forall x, x^* = \sum_{n=0}^{\infty} x^n \text{ exists.}$$

(+ axioms on block sums and distributivity)



Rationally Additive Semirings [Ésik & Kuich, 02]

\mathbb{W} is rationally additive if for every x in \mathbb{W} ,

$$\forall x, x^* = \sum_{n=0}^{\infty} x^n \text{ exists.}$$

(+ axioms on block sums and distributivity)

\mathbb{W} rationally additive \implies \mathbb{W} Conway :

$$(xy)^* = 1_{\mathbb{W}} + x(yx)^*y, \quad (x+y)^* = x^*(yx^*)^*.$$



Rationally Additive Semirings [Ésik & Kuich, 02]

\mathbb{W} is rationally additive if for every x in \mathbb{W} ,

$$\forall x, x^* = \sum_{n=0}^{\infty} x^n \text{ exists.}$$

(+ axioms on block sums and distributivity)

\mathbb{W} rationally additive \implies \mathbb{W} Conway :

$$(xy)^* = 1_{\mathbb{W}} + x(yx)^*y, \quad (x + y)^* = x^*(yx^*)^*.$$

Ex. $\mathbb{Q}_+ \cup \{\infty\}$, $(\mathbb{N} \cup \{\infty\}, \min, +)$, $([0; 1], \max, \cdot)$,
 $(\mathbb{Z} \cup \{-\infty, \omega\}, \max, +)$, $(\text{Rat}B^*, \cup, \cdot), \dots$



Rationally Additive Semirings [Ésik & Kuich, 02]

\mathbb{W} is rationally additive if for every x in \mathbb{W} ,

$$\forall x, x^* = \sum_{n=0}^{\infty} x^n \text{ exists.}$$

(+ axioms on block sums and distributivity)

\mathbb{W} rationally additive \implies \mathbb{W} Conway :

$$(xy)^* = 1_{\mathbb{W}} + x(yx)^*y, \quad (x + y)^* = x^*(yx^*)^*.$$

Ex. $\mathbb{Q}_+ \cup \{\infty\}$, $(\mathbb{N} \cup \{\infty\}, \min, +)$, $([0; 1], \max, \cdot)$,
 $(\mathbb{Z} \cup \{-\infty, \omega\}, \max, +)$, $(\text{Rat}B^*, \cup, \cdot), \dots$

Theorem.

If \mathbb{W} is rationally additive, every two-way \mathbb{W} -automaton is valid.



II. Representations



Two-way representation

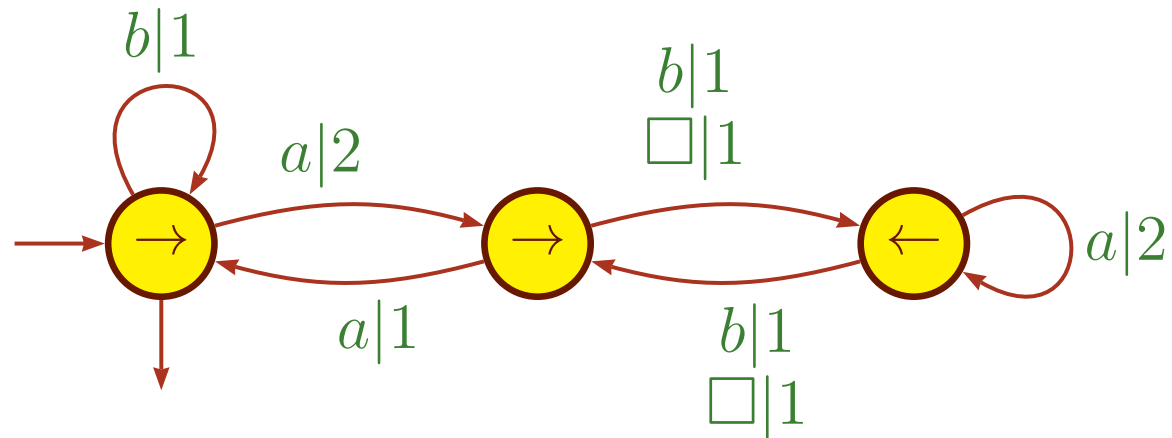

$$\mu(a) = \left[\begin{array}{cc|c} 0 & 2 & 0 \\ 1 & 0 & 0 \\ \hline 0 & 0 & 2 \end{array} \right], \mu(b) = \left[\begin{array}{cc|c} 1 & 0 & 0 \\ 0 & 0 & 1 \\ \hline 0 & 1 & 0 \end{array} \right], \diamond = \left[\begin{array}{cc|c} 1 & 0 & 0 \\ 0 & 1 & 1 \\ \hline 0 & 1 & 0 \end{array} \right],$$

$$I = \begin{bmatrix} 1 & 0 \end{bmatrix}, T = \begin{bmatrix} 1 \\ 0 \end{bmatrix}.$$



Two-way product on matrices

$$\left[\begin{array}{c|c} \vec{\rightarrow} & \vec{\leftarrow} \\ X & X \\ \hline \vec{\leftarrow} & \vec{\rightarrow} \\ X & X \end{array} \right] \text{ in } \mathbb{W}^{(m+n) \times (m+n)}$$



Two-way product on matrices

$$\left[\begin{array}{c|c} \vec{X} & \overleftarrow{X} \\ \hline \overleftarrow{X} & \overleftarrow{X} \end{array} \right] \cong \left[\begin{array}{c|c} \vec{Y} & \overleftarrow{Y} \\ \hline \overleftarrow{Y} & \overleftarrow{Y} \end{array} \right]$$

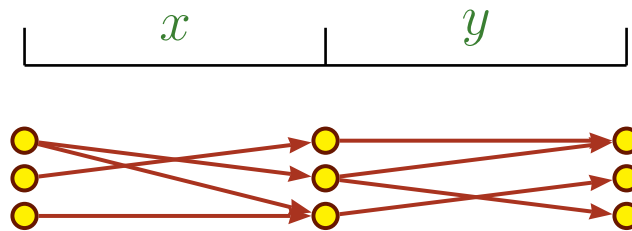

$$\vec{X} \cdot \vec{Y}$$



Two-way product on matrices

$$\left[\begin{array}{c|c} \vec{X} & \overleftarrow{X} \\ \hline \overrightarrow{X} & \overleftarrow{X} \end{array} \right] \cong \left[\begin{array}{c|c} \vec{Y} & \overleftarrow{Y} \\ \hline \overrightarrow{Y} & \overleftarrow{Y} \end{array} \right]$$

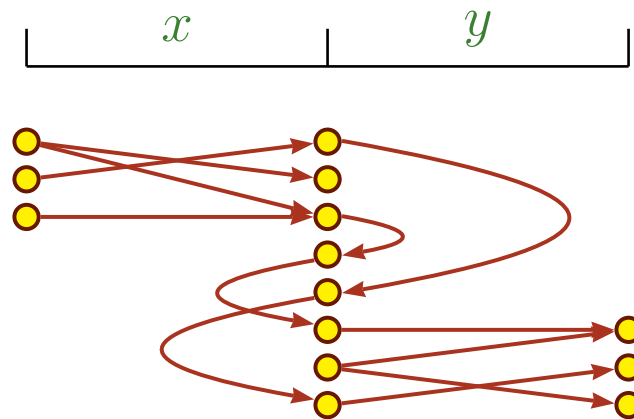

$$\vec{X} . \overleftarrow{Y} . \overrightarrow{X} . \vec{Y}$$



Two-way product on matrices

$$\left[\begin{array}{c|c} \overrightarrow{X} & \overleftarrow{X} \\ \hline \overleftarrow{X} & \overleftarrow{X} \end{array} \right] \mathfrak{z} \left[\begin{array}{c|c} \overrightarrow{Y} & \overleftarrow{Y} \\ \hline \overleftarrow{Y} & \overleftarrow{Y} \end{array} \right]$$

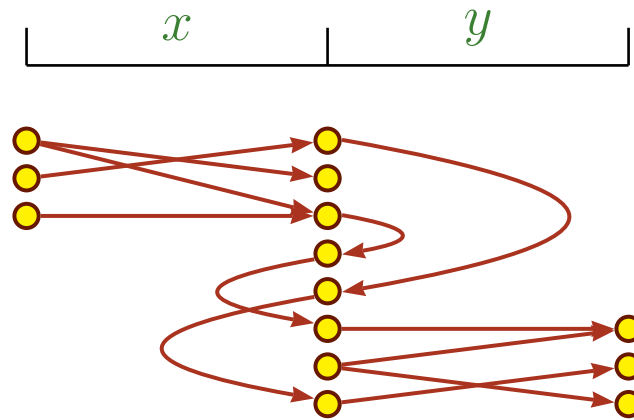

$$\overrightarrow{X} \mathfrak{z} \overrightarrow{Y} = \overrightarrow{X} . (\overleftarrow{Y} . \overleftarrow{X})^* . \overrightarrow{Y}$$



Two-way product on matrices

$$\left[\begin{array}{c|c} \overrightarrow{X} & \overleftarrow{X} \\ \hline \overleftarrow{X} & \overleftarrow{X} \end{array} \right] \otimes \left[\begin{array}{c|c} \overrightarrow{Y} & \overleftarrow{Y} \\ \hline \overleftarrow{Y} & \overleftarrow{Y} \end{array} \right] =$$

$$\left[\begin{array}{c|c} \overrightarrow{X} \cdot (\overleftarrow{Y} \cdot \overleftarrow{X})^* \cdot \overrightarrow{Y} & \overleftarrow{X} + \overrightarrow{X} \cdot (\overleftarrow{Y} \cdot \overleftarrow{X})^* \cdot \overleftarrow{Y} \cdot \overleftarrow{X} \\ \hline \overleftarrow{Y} + \overleftarrow{Y} \cdot \overleftarrow{X} \cdot (\overleftarrow{Y} \cdot \overleftarrow{X})^* \cdot \overrightarrow{Y} & \overleftarrow{Y} \cdot (\overleftarrow{X} \cdot \overleftarrow{Y})^* \cdot \overleftarrow{X} \end{array} \right] \cdot$$

Proposition. In a Conway semiring, this product is associative.

This product is inspired by [Birget, 90].



Two-way representation

Two-way \mathbb{W} -representation of size $m + n$: $\rho = (I, \mu, \diamond, T)$, with

$$I, T \in \mathbb{W}^m, \quad \diamond \in \mathbb{W}^{(m+n) \times (m+n)}, \quad (\overset{\rightarrow}{\diamond} = \text{Id}, \overset{\leftarrow}{\diamond} = 0),$$

$$\mu : A^* \rightarrow (\mathbb{W}^{(m+n) \times (m+n)}, \mathfrak{z}).$$



Two-way representation

Two-way \mathbb{W} -representation of size $m + n$: $\rho = (I, \mu, \diamond, T)$, with

$$I, T \in \mathbb{W}^m, \quad \diamond \in \mathbb{W}^{(m+n) \times (m+n)}, \quad (\overrightarrow{\diamond} = \text{Id}, \overleftarrow{\diamond} = 0),$$

$$\mu : A^* \rightarrow (\mathbb{W}^{(m+n) \times (m+n)}, \mathfrak{z}).$$

$$s_\rho = \sum_{w \in A^*} \overrightarrow{(I \cdot \diamond \mathfrak{z} \mu(w) \mathfrak{z} \diamond \cdot T)} w.$$

→ Two-way recognizable series $2\mathbb{W}\mathbf{Rec}A^*$.



Two-way representation

Two-way \mathbb{W} -representation of size $m + n$: $\rho = (I, \mu, \diamond, T)$, with

$$I, T \in \mathbb{W}^m, \quad \diamond \in \mathbb{W}^{(m+n) \times (m+n)}, \quad (\overrightarrow{\diamond} = \text{Id}, \overleftarrow{\diamond} = 0),$$

$$\mu : A^* \rightarrow (\mathbb{W}^{(m+n) \times (m+n)}, \mathfrak{z}).$$

$$s_\rho = \sum_{w \in A^*} \overrightarrow{(I \cdot \diamond \mathfrak{z} \mu(w) \mathfrak{z} \diamond \cdot T)} w.$$

→ Two-way recognizable series $2\mathbb{W}\mathbf{Rec}A^*$.

Theorem. \mathbb{W} rationally additive

$\implies s$ in $2\mathbb{W}\mathbf{Rec}A^*$ iff s realized by a $2\mathbb{W}$ -automaton.



Evaluation of a word

The weight of the word w by (I, μ, \diamond, T) is

$$\overrightarrow{I \cdot \diamond \mathfrak{z} \mu(w) \mathfrak{z} \diamond \cdot T}.$$

$$\begin{cases} \overrightarrow{I \cdot \diamond \mathfrak{z} \mu(wa)} = \overrightarrow{I \cdot \diamond \mathfrak{z} \mu(w)} \cdot \left(\overleftarrow{\mu(a)} \cdot \overrightarrow{\diamond \mathfrak{z} \mu(w)} \right)^* \cdot \overrightarrow{\mu(a)}, \\ \overrightarrow{\diamond \mathfrak{z} \mu(wa)} = \overrightarrow{\mu(a)} + \overleftarrow{\mu(a)} \cdot \overrightarrow{\diamond \mathfrak{z} \mu(w)} \cdot \left(\overleftarrow{\mu(a)} \cdot \overrightarrow{\diamond \mathfrak{z} \mu(w)} \right)^* \cdot \overrightarrow{\mu(a)}. \end{cases}$$

Proposition. The value of a word of length k by a representation of size $m + n$ can be evaluated with

- $m + mn$ registers;
- $\mathcal{O}(k(m^2n + \min(m^3, n^3)))$ multiplications.



Which series can be realized by 2WFA ?

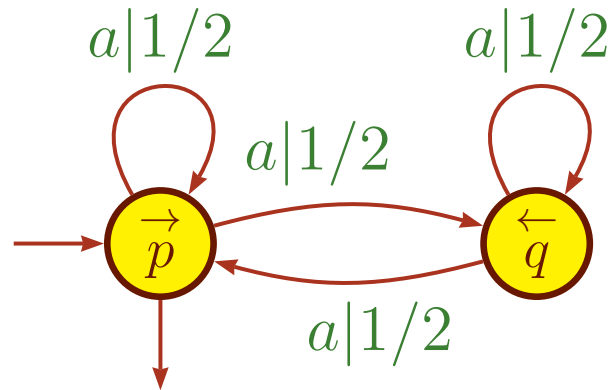

$$s_{\mathcal{A}} = \sum_{n=0}^{\infty} \frac{a^n}{n+1}.$$

This series is not in $\mathbb{Q}Rat a^*$.



III. Series



Hadamard-Rational series

Entrywise operations:

• Sum: $s + t = \sum_{w \in A^*} (\langle s, w \rangle + \langle t, w \rangle) w;$

• Hadamard product: $s \odot t = \sum_{w \in A^*} (\langle s, w \rangle \cdot \langle t, w \rangle) w;$

• Hadamard iteration: $s^{\otimes} = \sum_{w \in A^*} \langle s, w \rangle^* w;$

$$\mathbb{W}\text{HadRat}A^* = \langle \mathbb{W}\text{Rat}A^* \rangle_{+, \odot, \otimes}$$

• Mirror operation:

$$\bar{s} = \sum_{w \in A^*} \langle s, \bar{w} \rangle w.$$

$$\mathbb{W}\text{MHadRat}A^* = \langle \mathbb{W}\text{HadRat}A^* \rangle_{\text{mir}}$$



Some classes of formal power series

Polynomials

$$\text{Rat} = \langle \text{Pol} \rangle_{+, \cdot, *}$$

$$\text{MRat} = \langle \text{Rat} \rangle_{\text{mir}}$$

$$\text{HadRat} = \langle \text{Rat} \rangle_{+, \odot, \otimes}$$

$$\text{MHadRat} = \langle \text{HadRat} \rangle_{\text{mir}}$$

$$\text{RH} = \langle \text{Pol} \rangle_{+, \cdot, *, \odot, \otimes}$$

$$\text{MRH} = \langle \text{RH} \rangle_{\text{mir}}$$

Series



Which series can be realized by 2WFA ?

Series realized by

- **rotating** $2\mathbb{WFA}$ are closed under $+$, \odot and \otimes ;
- **sweeping** $2\mathbb{WFA}$ are closed under $+$, \odot , \otimes and mirror.

Proposition.

- **rotating** $2\mathbb{WFA}$ can realize every series in $\mathbb{W}\text{HadRat}A^*$;
- **sweeping** $2\mathbb{WFA}$ can realize every series in $\mathbb{W}\text{MHadRat}A^*$.



Which series can be realized by 2WFA ?

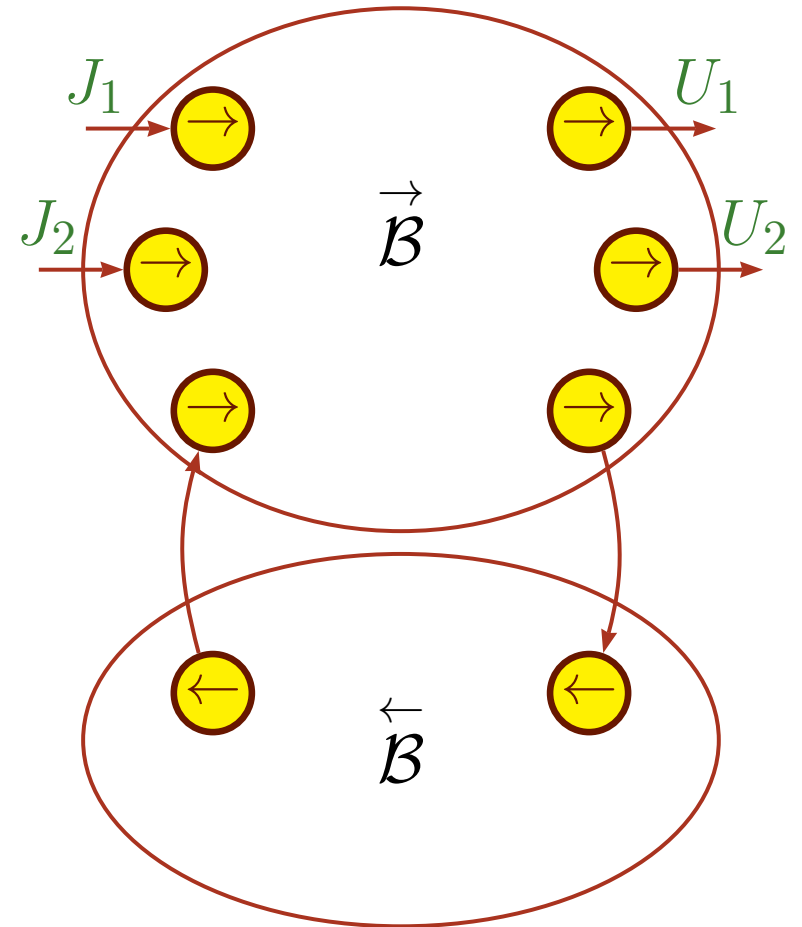
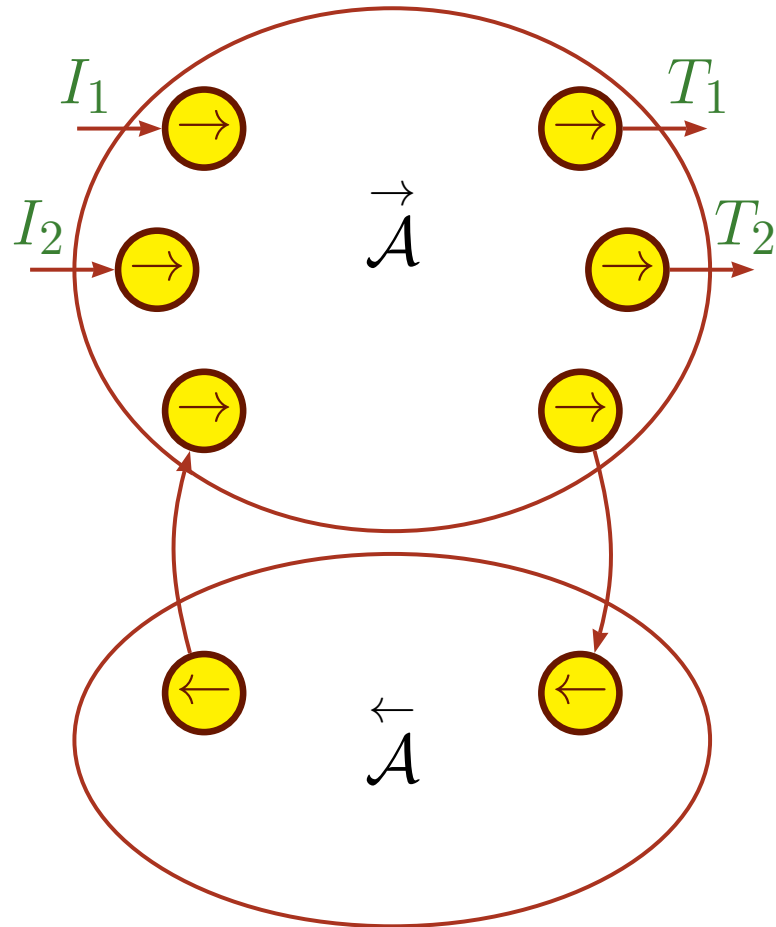

Which series can be realized by 2WFA ?

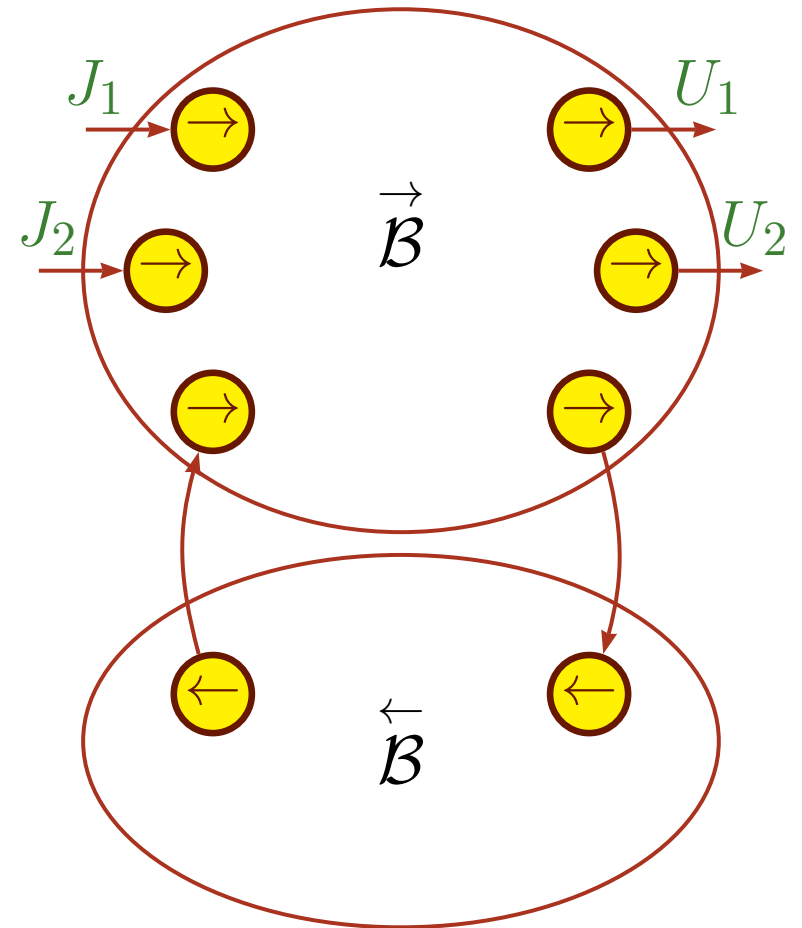
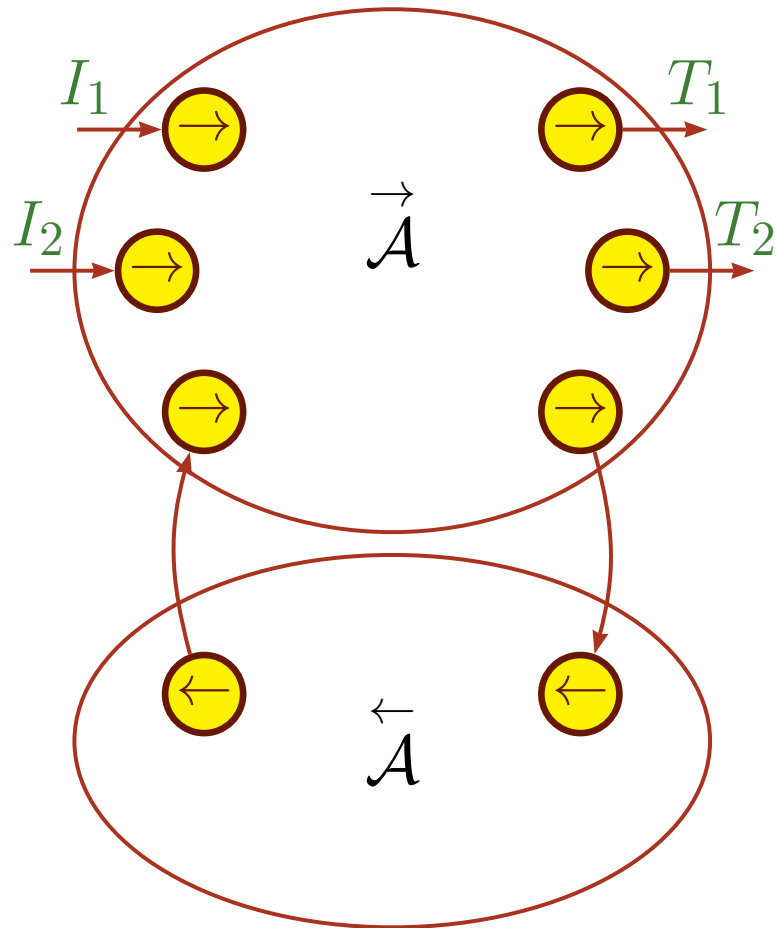

$$A + B$$

Which series can be realized by 2WFA ?

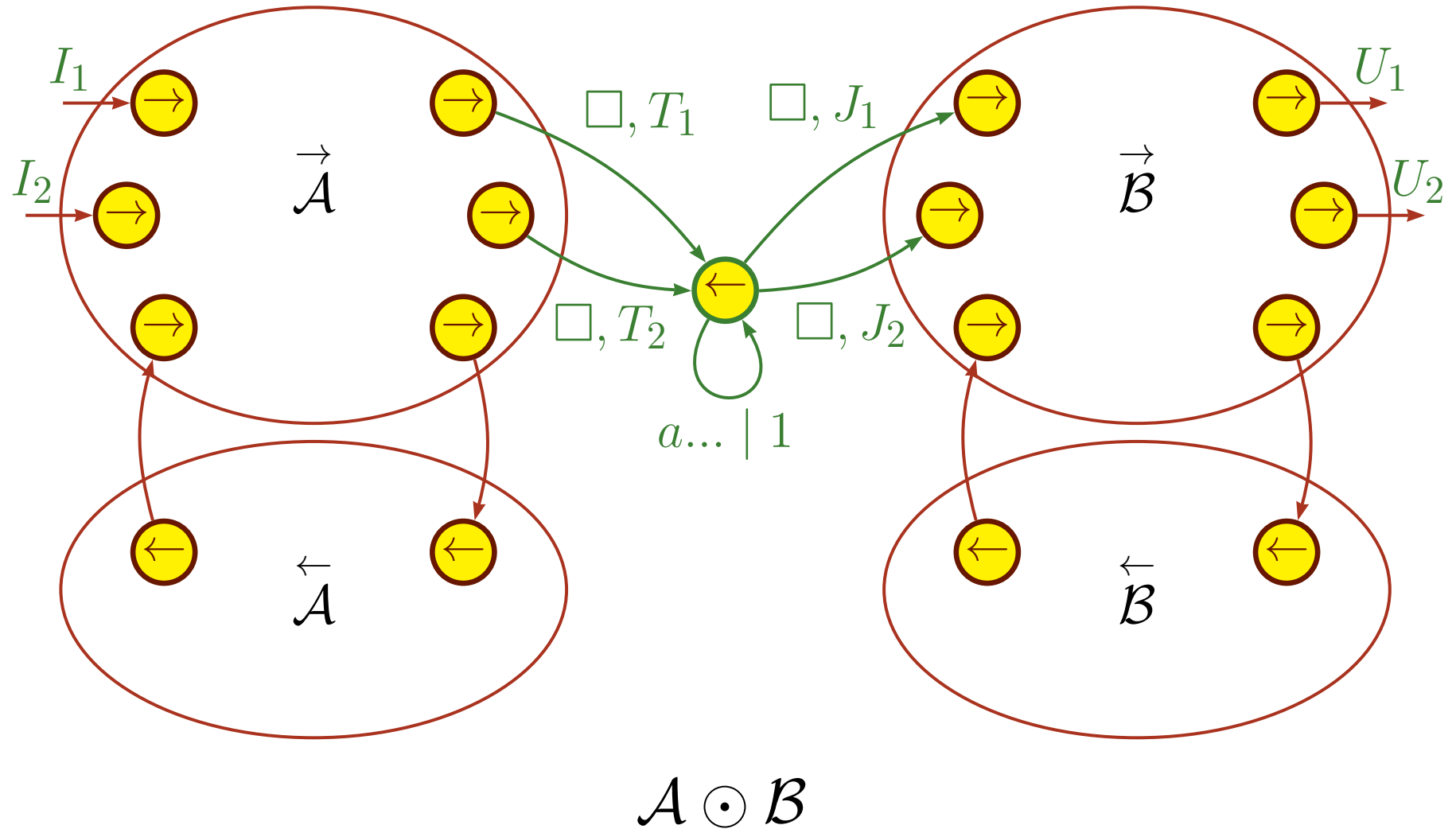

Which series can be realized by 2WFA ?

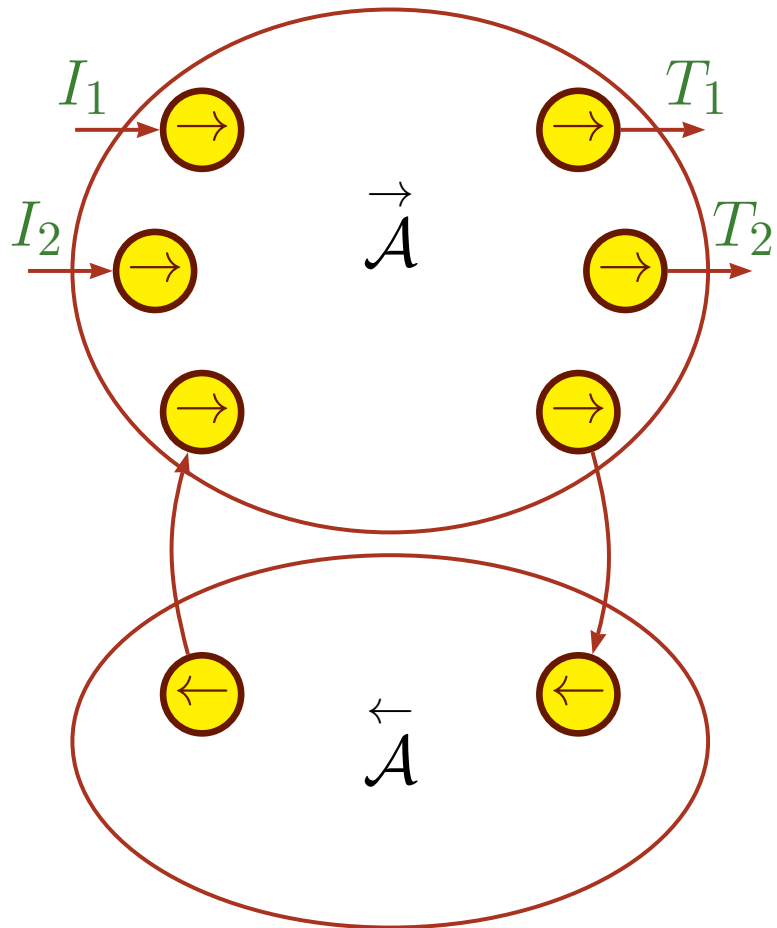

Which series can be realized by 2WFA ?

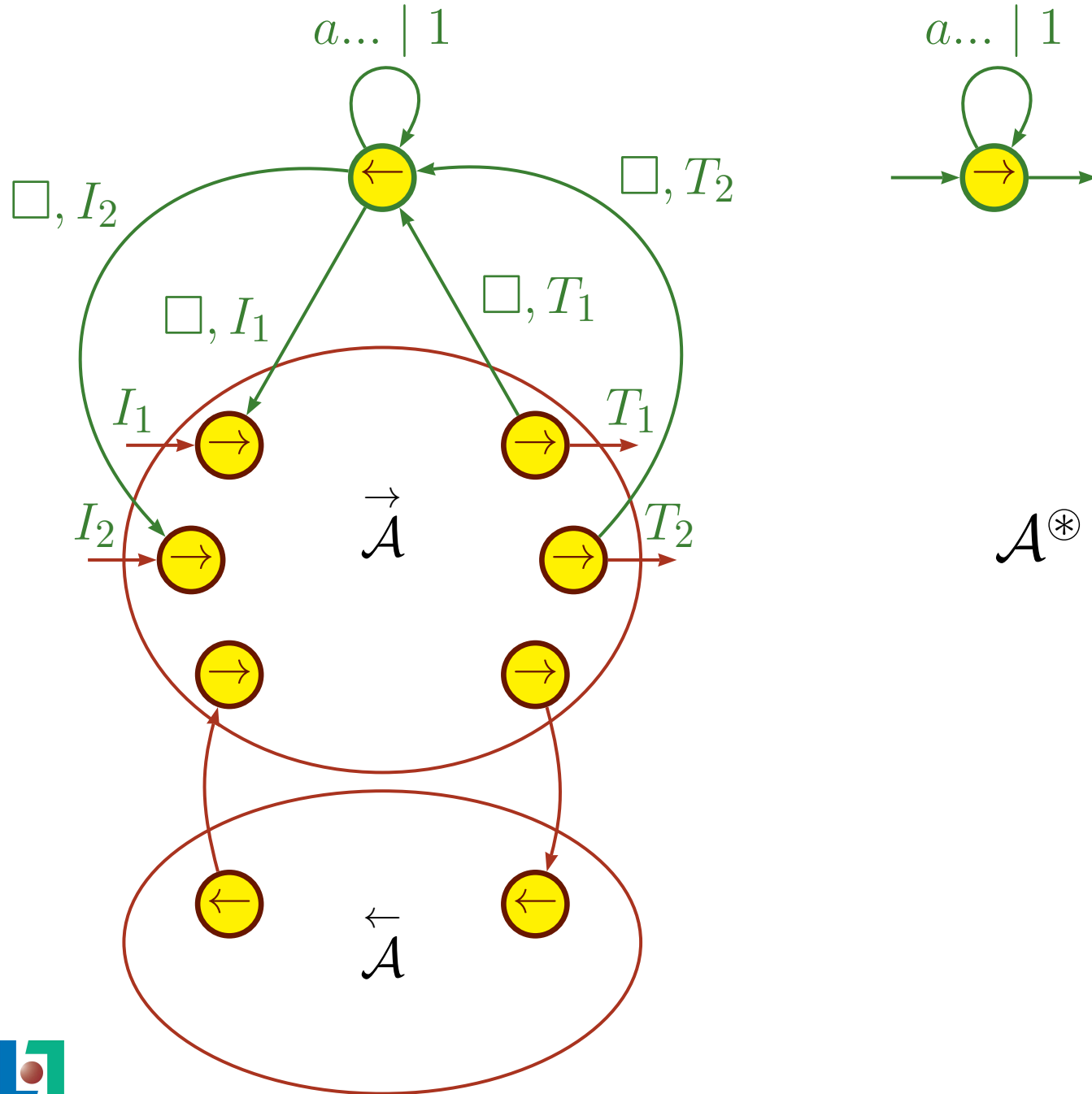

Which series can be realized by 2WFA ?

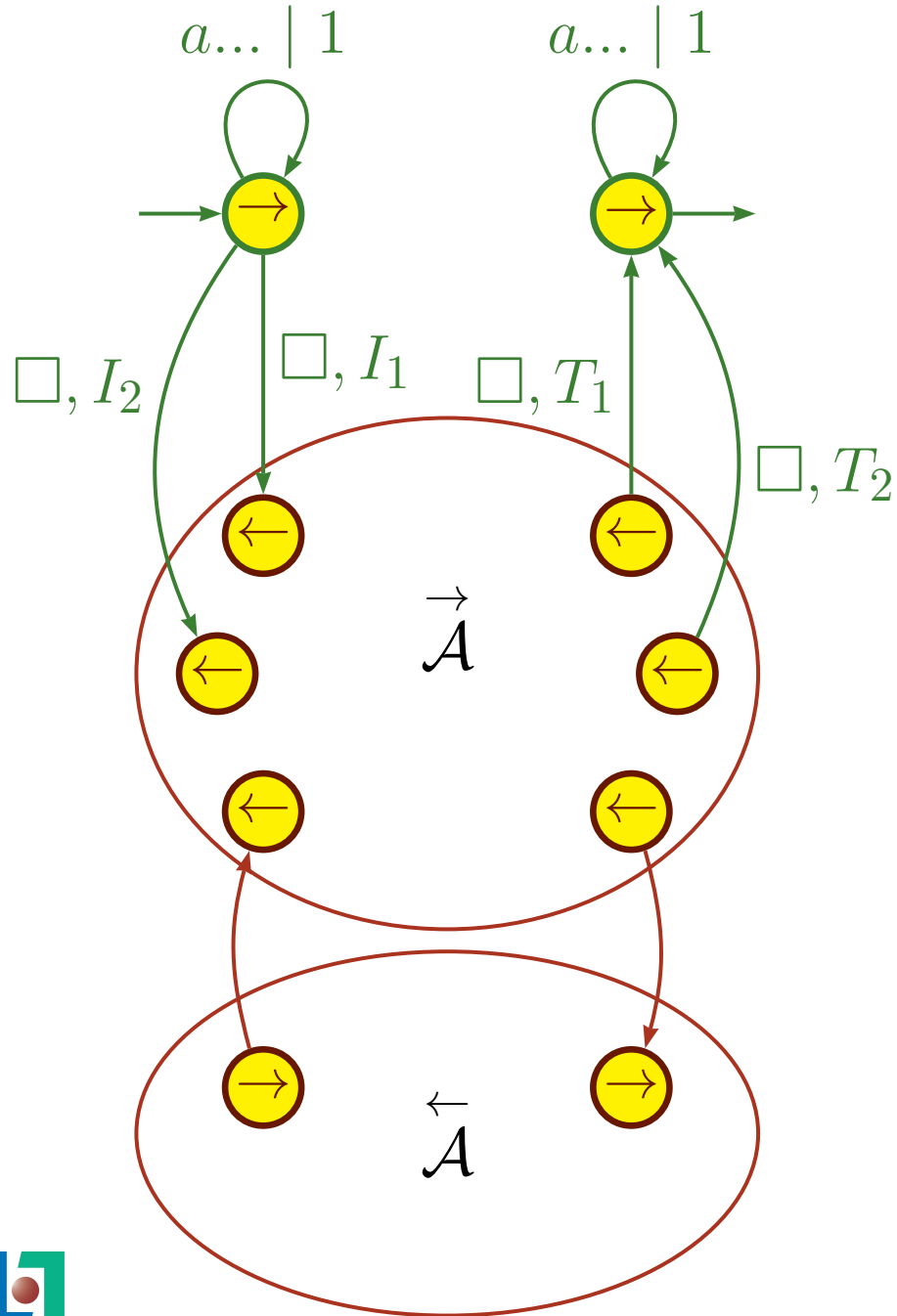

\overline{A}



Which series can be realized by 2WFA ?

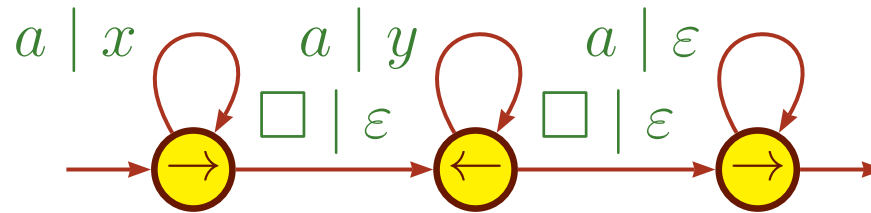

$$s = \sum_{n=0}^{\infty} (x^n y^n) a^n.$$

Series $s \cdot s$ and s^* are not in $2\mathbb{W}\text{Rec}A^*$.

Proposition. (For some semirings \mathbb{W}),
 $2\mathbb{W}\text{Rec}A^*$ is not closed under Cauchy product and Kleene star.



Which series can be realized by 2WFA ?

$$s = \sum_{i,j \in \mathbb{N}} (x^i y^i x^j y^j) a^i b a^j.$$

This series can be realized by a two-way transducer.

$$s = \sum_{k \in \mathbb{N}} \{x^i y^i x^j y^j \mid i + j + 1 = k\} a^k.$$

This series cannot be realized by a two-way transducer.

Proposition. (For some semirings \mathbb{W}),
 $2\mathbb{W}\text{Rec}A^*$ is not closed by length-preserving morphisms.



IV. Fixed-point equations



Operations on matrices

We consider matrices of series.

Caveat

\odot is not the Hadamard product of matrices:

$$(M \odot N)_{i,j} = \sum_{k=1}^h M_{i,k} \odot M_{k,j}.$$

Star $\longrightarrow M^{\circledast} = \sum_{k \leq 0} M^{\odot k}.$



Equations for 2WFA

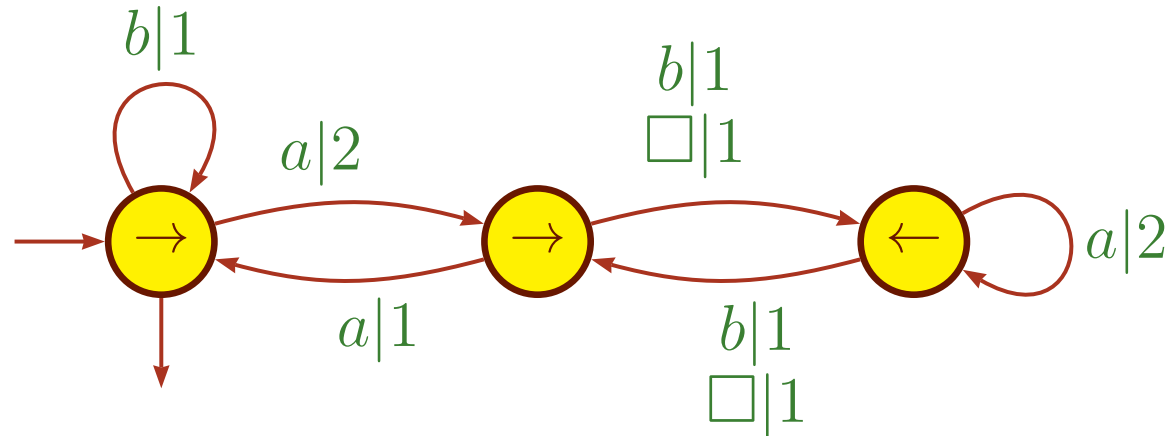

$$M = \left[\begin{array}{cc|c} b & 2a & 0 \\ a & 0 & b \\ \hline 0 & b & 2a \end{array} \right], \diamond = \left[\begin{array}{cc|c} 1 & 0 & 0 \\ 0 & 1 & 1 \\ \hline 0 & 1 & 0 \end{array} \right],$$

$$I = \begin{bmatrix} 1 & 0 \end{bmatrix}, T = \begin{bmatrix} 1 \\ 0 \end{bmatrix}.$$

$Y \in \mathbb{W}\langle\langle A^* \rangle\rangle^m$: Y_p series realized when p is initial without reading any left endmark.



Equations for 2WFA

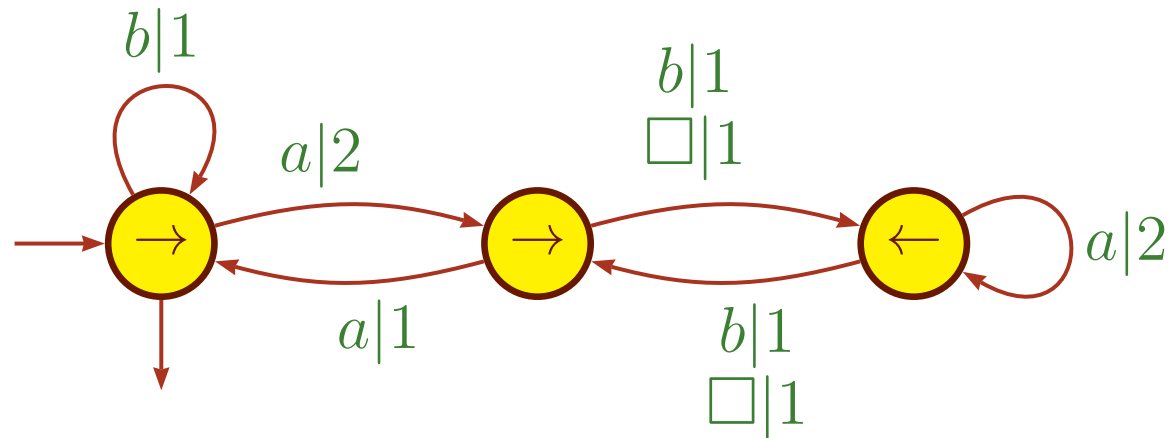

$$M = \left[\begin{array}{cc|c} b & 2a & 0 \\ a & 0 & b \\ \hline 0 & b & 2a \end{array} \right], \diamond = \left[\begin{array}{cc|c} 1 & 0 & 0 \\ 0 & 1 & 1 \\ \hline 0 & 1 & 0 \end{array} \right],$$

$$I = \begin{bmatrix} 1 & 0 \end{bmatrix}, T = \begin{bmatrix} 1 \\ 0 \end{bmatrix}.$$

$X \in \mathbb{W}\langle\langle A^* \rangle\rangle^{m \times n}$: $\langle X_{p,q}, w \rangle$ weights of paths compliant with w where head starts and stops at position 1.



Equations for 2WFA

$$X =$$



Equations for 2WFA

$$X = \overleftarrow{\diamond}$$

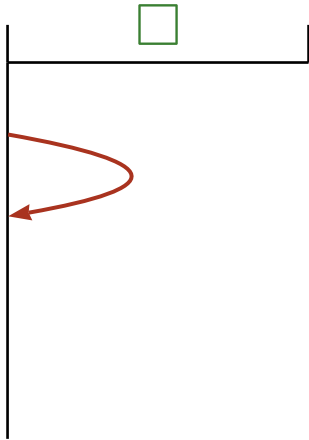

Equations for 2WFA

$$X = \overset{\leftarrow}{\diamond} + \overset{\leftarrow}{M}$$

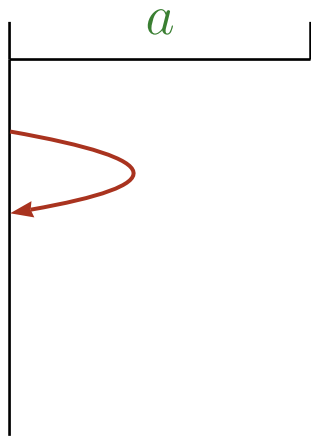

Equations for 2WFA

$$X = \overset{\leftarrow}{\diamond} + \overset{\leftarrow}{M} \cdot A^*$$

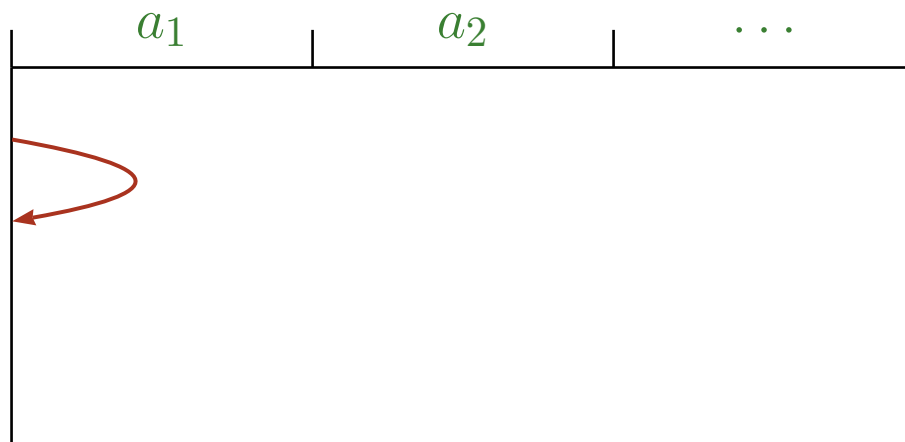

Equations for 2WFA

$$X = \overleftarrow{\diamond} + \overleftarrow{M} \cdot A^* + (\overrightarrow{M} \cdot X)$$

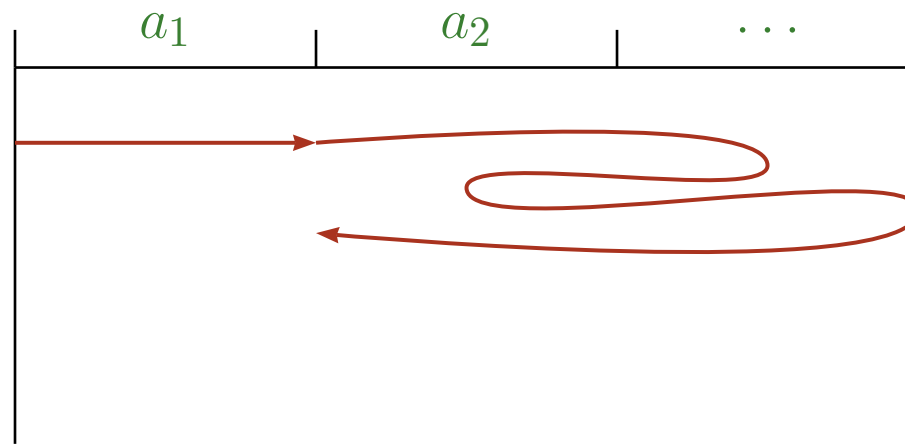

Equations for 2WFA

$$X = \overleftarrow{\diamond} + \overleftarrow{M}.A^* + (\overrightarrow{M}.X) \odot (\overleftarrow{M}.X)$$

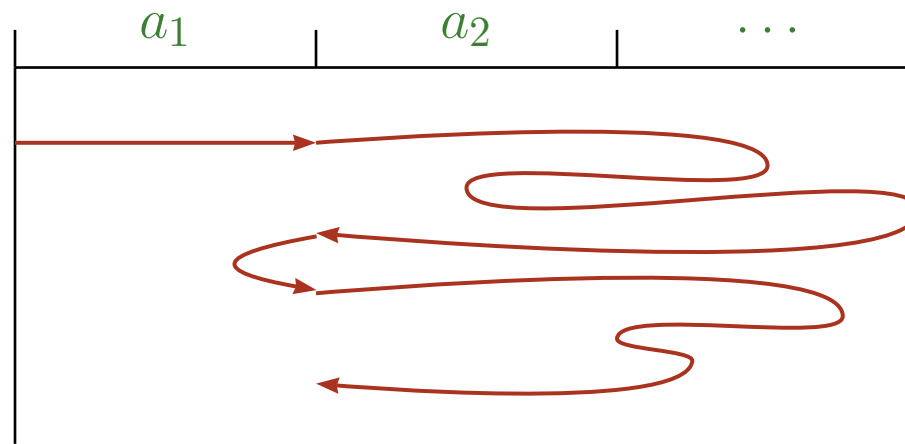

Equations for 2WFA

$$X = \overleftarrow{\diamond} + \overleftarrow{M}.A^* + (\overrightarrow{M}.X) \odot (\overleftarrow{M}.X)^{\otimes}$$

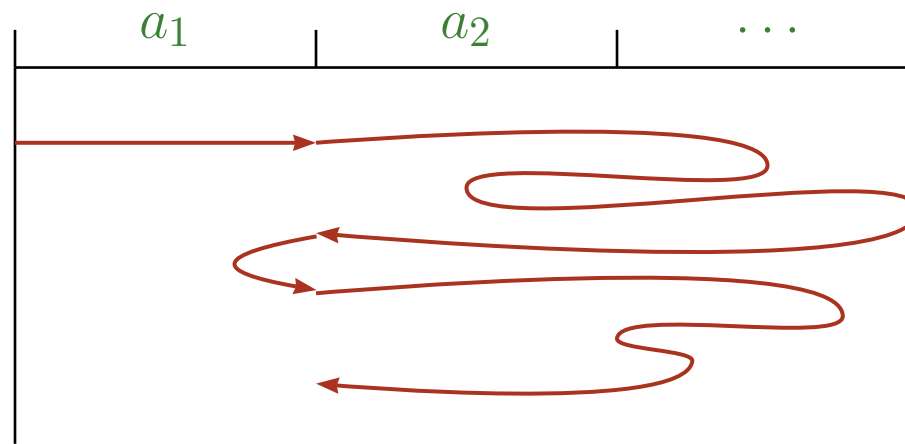

Equations for 2WFA

$$X = \overleftarrow{\diamond} + \overleftarrow{M}.A^* + (\overrightarrow{M}.X) \odot (\overleftarrow{M}.X)^{\otimes} \odot (\overleftarrow{M}.A^*)$$

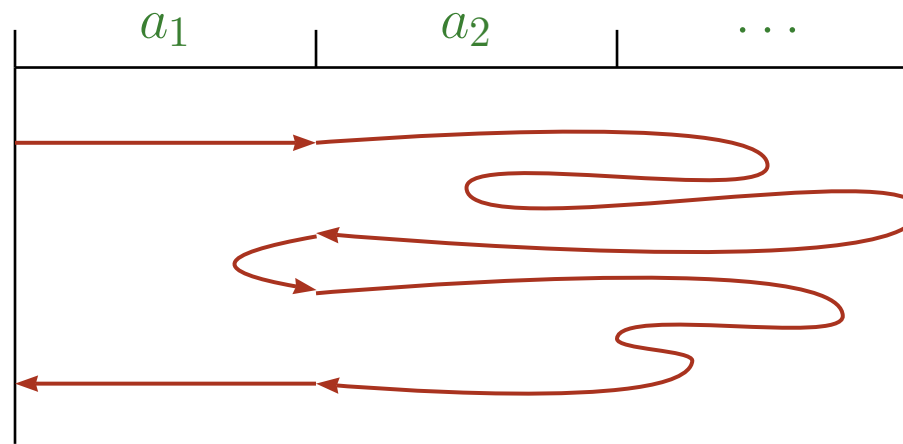

Equations for 2WFA

$$X = \overset{\leftarrow}{\diamond} + \overset{\leftarrow}{M}.A^* + (\vec{M}.X) \odot (\overset{\leftarrow}{M}.X)^{\odot *} \odot (\overset{\leftarrow}{M}.A^*)$$

$$Y =$$



Equations for 2WFA

$$X = \overset{\leftarrow}{\diamond} + \overset{\leftarrow}{M}.A^* + (\vec{M}.X) \odot (\overset{\leftarrow}{M}.X)^{\otimes} \odot (\overset{\leftarrow}{M}.A^*)$$

$$Y = T$$

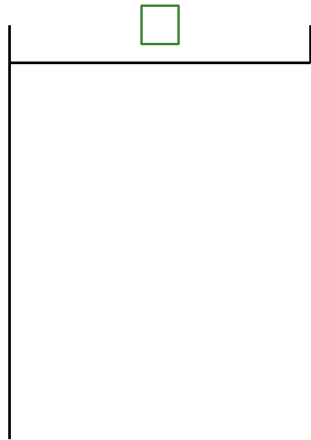

Equations for 2WFA

$$X = \overleftarrow{\diamond} + \overleftarrow{M}.A^* + (\overrightarrow{M}.X) \odot (\overleftarrow{M}.X)^{\otimes} \odot (\overleftarrow{M}.A^*)$$

$$Y = \overrightarrow{T} + \overrightarrow{M}.Y$$

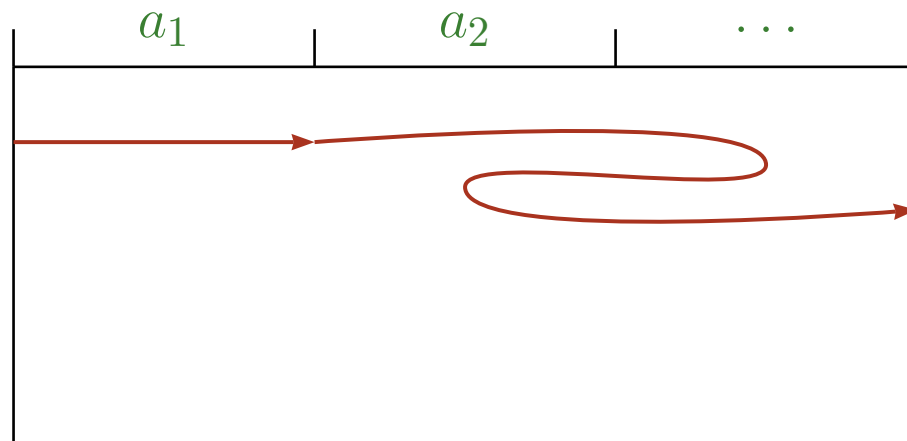

Equations for 2WFA

$$X = \overleftarrow{\diamond} + \overleftarrow{M}.A^* + (\overrightarrow{M}.X) \odot (\overleftrightarrow{M}.X)^{\otimes} \odot (\overleftarrow{M}.A^*)$$

$$Y = T + \overrightarrow{M}.Y + \overrightarrow{M}.X \odot (\overleftrightarrow{M}.X)^{\otimes} \odot (\overleftrightarrow{M}.Y)$$

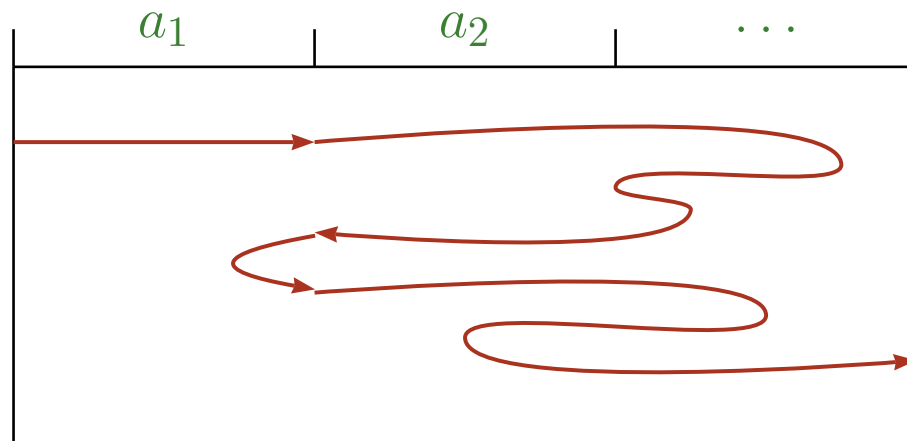

Equations for 2WFA

$$X = \overset{\leftarrow}{\diamond} + \overset{\leftarrow}{M}.A^* + (\vec{M}.X) \odot (\overset{\curvearrowright}{M}.X)^{\ast} \odot (\overset{\leftarrow}{M}.A^*)$$

$$Y = T + \vec{M}.Y + \vec{M}.X \odot (\overset{\curvearrowright}{M}.X)^{\ast} \odot (\overset{\curvearrowright}{M}.Y)$$

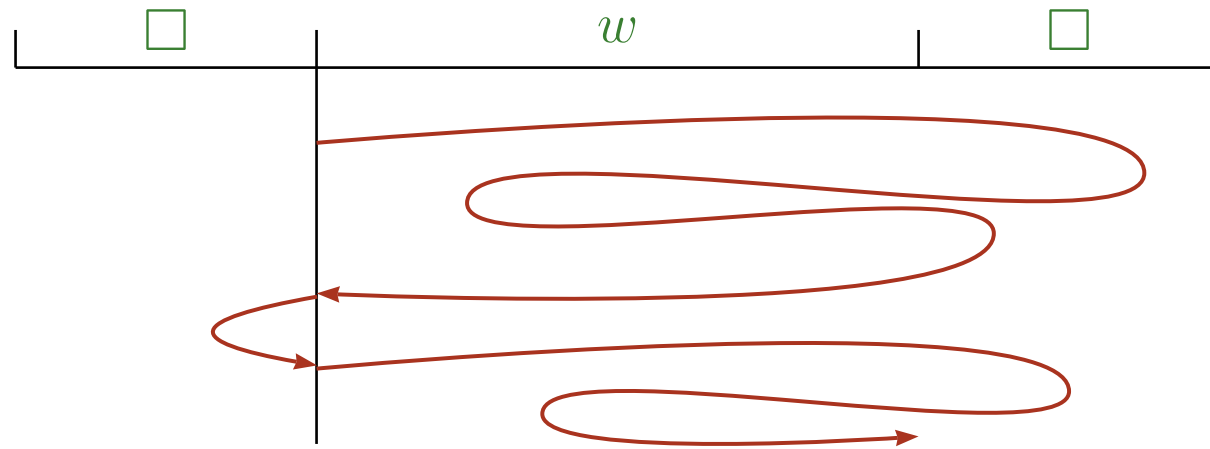

Theorem. $s_{\mathcal{A}} = I.(X.\overset{\curvearrowright}{\diamond})^{\ast} \odot Y$

Solving this equation

In general, I do not know how to solve this equation.



Rotating WFA

$$\begin{cases} X = \overleftarrow{\diamond} + \overleftarrow{M} \cdot A^* + (\overrightarrow{M} \cdot X) \odot (\overleftrightarrow{M} \cdot X)^{\otimes} \odot (\overleftarrow{M} \cdot A^*) & \text{(bwd half-turn)} \\ Y = T + \overrightarrow{M} \cdot Y + (\overrightarrow{M} \cdot X) \odot (\overleftrightarrow{M} \cdot X)^{\otimes} \odot (\overleftrightarrow{M} \cdot Y) & \text{(forward)} \end{cases}$$

$$\overleftarrow{M} = 0, \overleftrightarrow{M} = 0, \overleftarrow{M} = A.$$



Rotating WFA

$$\begin{cases} X = \overleftarrow{\diamond} + \overleftarrow{\vec{M}} \cdot \Lambda^* + (\overrightarrow{\vec{M}} \cdot X) \ominus (\overleftrightarrow{\vec{M}} \cdot X)^{\otimes} \ominus (\overleftarrow{\vec{M}} \cdot \Lambda^*) & \text{(bwd half-turn)} \\ Y = T + \overrightarrow{\vec{M}} \cdot Y + (\overrightarrow{\vec{M}} \cdot X) \odot (\overleftrightarrow{\vec{M}} \cdot X)^{\otimes} \odot (\overleftrightarrow{\vec{M}} \cdot Y) & \text{(forward)} \end{cases}$$

$$\overleftarrow{\vec{M}} = 0, \overleftrightarrow{\vec{M}} = 0, \overleftarrow{\vec{M}} = A.$$



Rotating WFA

$$\begin{cases} X = \overleftarrow{\diamond} + \overleftarrow{\vec{M}} \cdot \Lambda^* + (\overrightarrow{\vec{M}} \cdot X) \ominus (\overleftrightarrow{\vec{M}} \cdot X)^{\otimes} \ominus (\overleftarrow{\vec{M}} \cdot \Lambda^*) & \text{(bwd half-turn)} \\ Y = T + \overrightarrow{\vec{M}} \cdot Y + (\overrightarrow{\vec{M}} \cdot X) \odot (\overleftrightarrow{\vec{M}} \cdot X)^{\otimes} \odot (\overleftrightarrow{\vec{M}} \cdot Y) & \text{(forward)} \end{cases}$$

$$\overleftarrow{\vec{M}} = 0, \overleftrightarrow{\vec{M}} = 0, \overleftarrow{\vec{M}} = A.$$

$$X = \overrightarrow{\vec{M}}^* \cdot \overleftarrow{\diamond}, \quad Y = \overrightarrow{\vec{M}}^* \cdot T.$$

$$s_\rho = I.(\overrightarrow{\vec{M}}^* \cdot \overleftarrow{\diamond} \cdot \overleftrightarrow{\diamond})^{\otimes} \odot \overrightarrow{\vec{M}}^* \cdot T.$$



Rotating WFA

$$\begin{cases} X = \overleftarrow{\diamond} + \overleftarrow{\vec{M}} \cdot \Lambda^* + (\overrightarrow{\vec{M}} \cdot X) \ominus (\overrightarrow{\vec{M}} \cdot X)^{\otimes} \ominus (\overleftarrow{\vec{M}} \cdot \Lambda^*) & \text{(bwd half-turn)} \\ Y = T + \overrightarrow{\vec{M}} \cdot Y + (\overrightarrow{\vec{M}} \cdot X) \odot (\overrightarrow{\vec{M}} \cdot X)^{\otimes} \odot (\overrightarrow{\vec{M}} \cdot Y) & \text{(forward)} \end{cases}$$

$$\overleftarrow{\vec{M}} = 0, \overrightarrow{\vec{M}} = 0, \overleftarrow{\vec{M}} = A.$$

$$X = \overrightarrow{\vec{M}}^* \cdot \overleftarrow{\diamond}, \quad Y = \overrightarrow{\vec{M}}^* \cdot T.$$

$$s_\rho = I.(\overrightarrow{\vec{M}}^* \cdot \overleftarrow{\diamond} \cdot \overrightarrow{\diamond})^{\otimes} \odot \overrightarrow{\vec{M}}^* \cdot T.$$

Theorem. Rotating $2\mathbb{W}\text{Rec}A^* = \mathbb{W}\text{HadRat}A^*$.



Sweeping WFA

$$\begin{cases} X = \overleftarrow{\diamond} + \overleftarrow{M} \cdot A^* + (\overrightarrow{M} \cdot X) \odot (\overleftrightarrow{M} \cdot X)^{\otimes} \odot (\overleftarrow{M} \cdot A^*) & \text{(bwd half-turn)} \\ Y = T + \overrightarrow{M} \cdot Y + (\overrightarrow{M} \cdot X) \odot (\overleftrightarrow{M} \cdot X)^{\otimes} \odot (\overleftrightarrow{M} \cdot Y) & \text{(forward)} \end{cases}$$

$$\overleftarrow{M} = 0, \overleftrightarrow{M} = 0.$$



Sweeping WFA

$$\begin{cases} X = \overleftarrow{\diamond} + \overleftarrow{\vec{M}} \cdot \mathbf{A}^* + (\overrightarrow{\vec{M}} \cdot X) \ominus (\overleftrightarrow{\vec{M}} \cdot X)^{\otimes} \odot (\overleftarrow{\vec{M}} \cdot \mathbf{A}^*) & \text{(bwd half-turn)} \\ Y = T + \overrightarrow{\vec{M}} \cdot Y + (\overrightarrow{\vec{M}} \cdot X) \odot (\overleftrightarrow{\vec{M}} \cdot X)^{\otimes} \ominus (\overleftrightarrow{\vec{M}} \cdot Y) & \text{(forward)} \end{cases}$$

$$\overleftarrow{\vec{M}} = 0, \overleftrightarrow{\vec{M}} = 0.$$



Sweeping WFA

$$\begin{cases} X = \overleftarrow{\diamond} + \overleftarrow{M} \cdot A^* + (\overrightarrow{M} \cdot X) \odot (\overleftarrow{M} \cdot X)^{\circledast} \odot (\overleftarrow{M} \cdot A^*) & \text{(bwd half-turn)} \\ Y = T + \overrightarrow{M} \cdot Y + (\overrightarrow{M} \cdot X) \odot (\overleftarrow{M} \cdot X)^{\circledast} \odot (\overrightarrow{M} \cdot Y) & \text{(forward)} \end{cases}$$

$$\overleftarrow{M} = 0, \overrightarrow{M} = 0.$$

$$X = (\overrightarrow{M} \cdot \overleftarrow{\diamond}) \odot \overleftarrow{M}^*, \quad Y = \overrightarrow{M} \cdot T.$$

$$s_\rho = I.((\overrightarrow{M} \cdot \overleftarrow{\diamond}) \odot \overleftarrow{M} \cdot \overleftarrow{\diamond})^{\circledast} \odot \overrightarrow{M} \cdot T.$$

Theorem. Sweeping $2\mathbb{W}\text{Rec}A^* = \mathbb{W}\text{M}\text{HadRat}A^*$.

Corollary. \mathbb{W} commutative \implies Sweeping \equiv Rotating.



A hierarchy of series

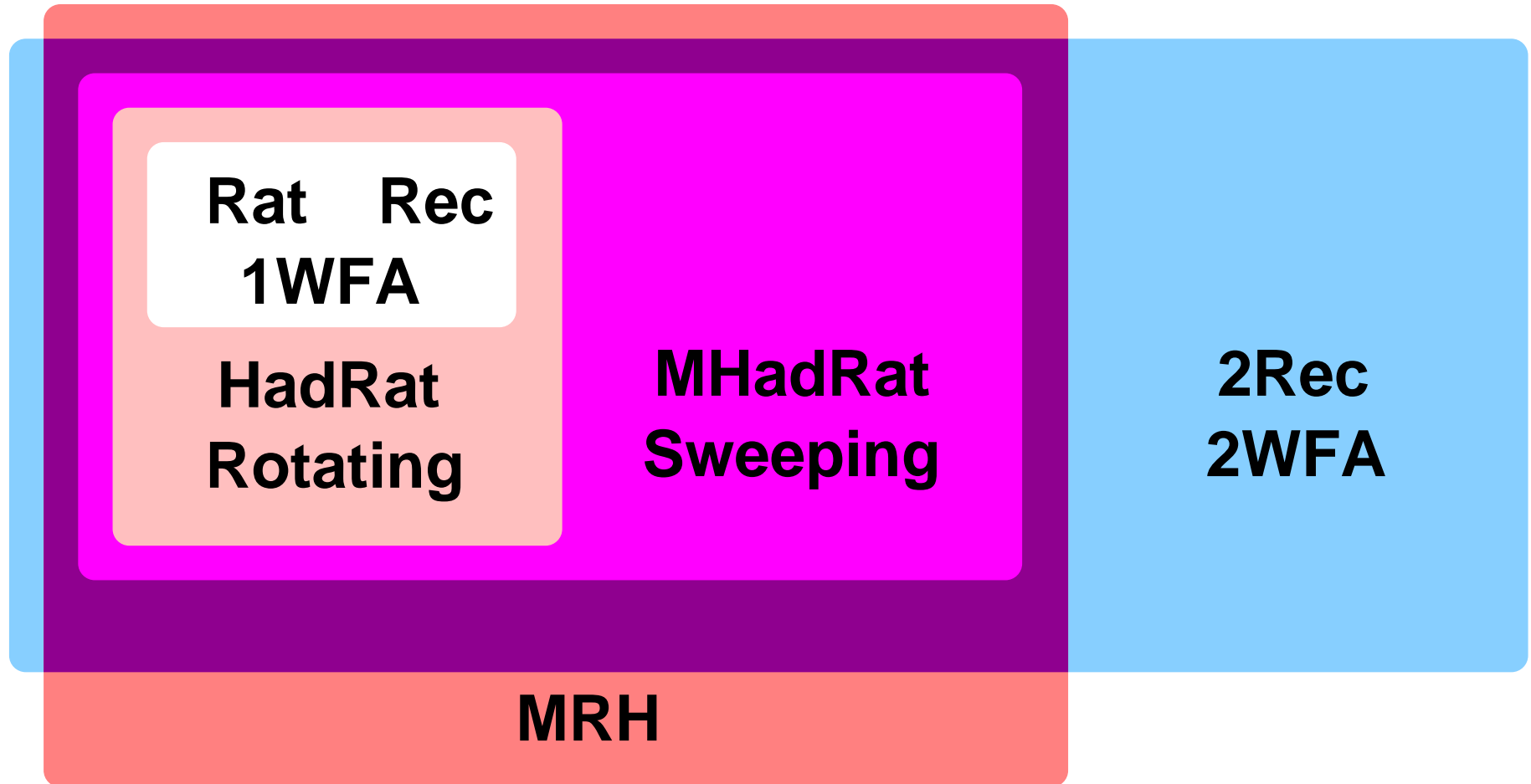

Rings are not so nice

In rings, $(-1)^*$ can not be defined consistently.

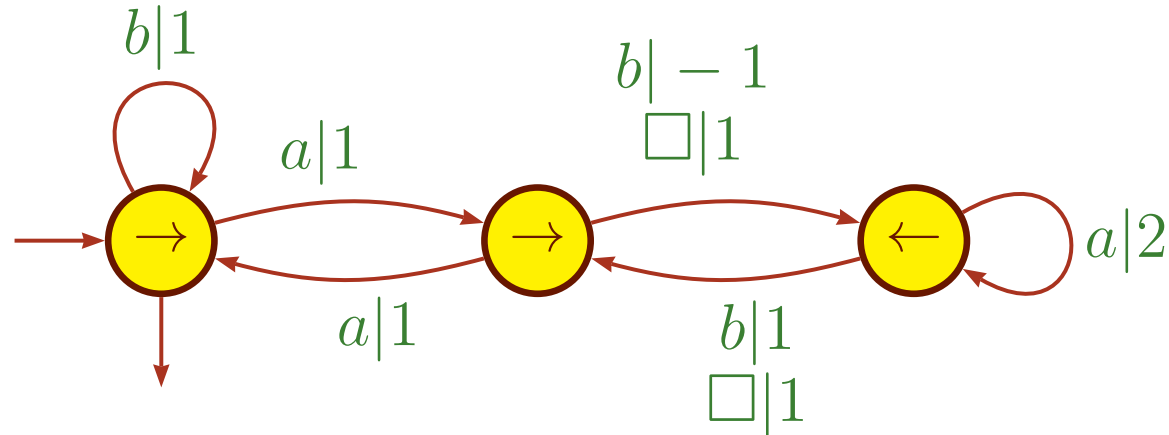

$$\begin{aligned} \vec{\mu}(bb) &= \vec{\mu}(b) \cdot (\overleftarrow{\mu}(b) \cdot \overrightarrow{\mu}(b))^* \cdot \vec{\mu}(b) \\ &= \begin{bmatrix} 1 & 0 \\ 0 & 0 \end{bmatrix} \cdot \left(\begin{bmatrix} 0 \\ -1 \end{bmatrix} \cdot \begin{bmatrix} 0 & 1 \end{bmatrix} \right)^* \cdot \begin{bmatrix} 1 & 0 \\ 0 & 0 \end{bmatrix} \end{aligned}$$



Rings are not so nice

In rings, $(-1)^*$ can not be defined consistently.

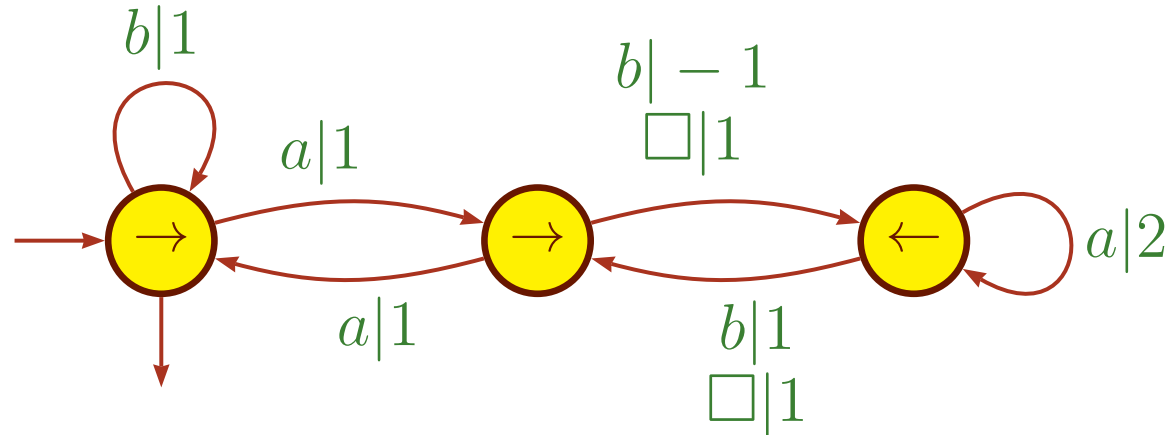

$$\begin{aligned} \vec{\mu}(bb) &= \vec{\mu}(b) \cdot (\overleftarrow{\mu}(b) \cdot \overrightarrow{\mu}(b))^* \cdot \vec{\mu}(b) \\ &= \begin{bmatrix} 1 & 0 \\ 0 & 0 \end{bmatrix} \cdot \begin{bmatrix} 0 & 0 \\ 0 & -1 \end{bmatrix}^* \cdot \begin{bmatrix} 1 & 0 \\ 0 & 0 \end{bmatrix} \end{aligned}$$



Rings are not so nice

$$\sum_{n=0}^{\infty} \frac{a^n}{n+1} = \left(a^* - \left(\frac{a}{2} \right)^* \cdot \left(\frac{a}{2} \right)^* \right)^{\circledast} \odot \left(\frac{a}{2} \right)^* \in \mathbb{Q}\text{HadRat}a^*$$

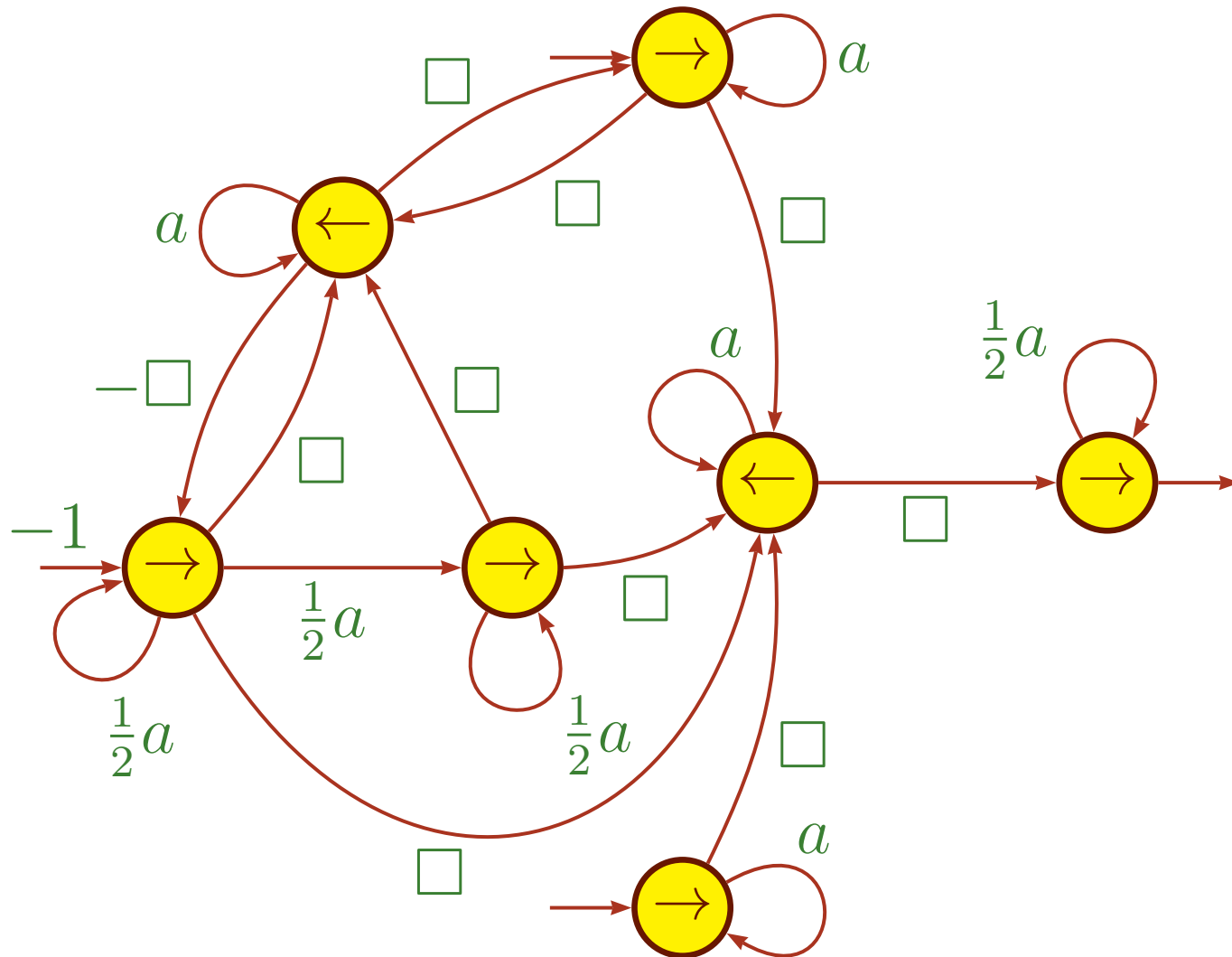

Ongoing work

- Two-way over rings ? fields ?
- Conversion algorithms
- Description of series for simple automata (\mathbb{W} non commutative)
- Decidability of subclasses ?
Necessary conditions (Pumping lemma...)

